



Structural bearings

Infrastructure | Buildings | Industrial structures

Deformation and sliding bearing with PTFE sliding surface



LASTO® FLONBLOCK Type D

low-friction, durable, high-grade

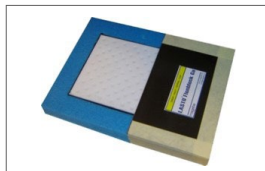

mageba



LASTO®FLONBLOCK Type D

Principle

LASTO®FLONBLOCK Type D are reinforced elastomeric bearings with a PTFE sliding layer vulcanised onto one side. The PTFE surface is matched with a sliding plate made from buffed stainless steel, with a specially-treated smooth surface texture, designed to achieve minimum friction coefficients. LASTO®FLONBLOCK knuckle and sliding point bearings are used to absorb high vertical loads, torsion of the bearing surfaces, and horizontal displacements in the longitudinal and transverse directions with the minimum possible friction.

Applications

LASTO®FLONBLOCK Type D can be used wherever the displacements of the structure generate restoring forces that are too large, or where the range of permissible displacements of LASTO®BLOCK bearings is not sufficient. Despite a low bearing height, the sliding layer permits significant displacements. The forces to be absorbed are transmitted properly to the supporting structure, and rotations are absorbed through elasticity.

LASTO®FLONBLOCK knuckle and sliding point bearings deliver high-quality support in building construction, civil engineering, bridge construction, steel, wood and concrete structures, and in prefabricated construction.

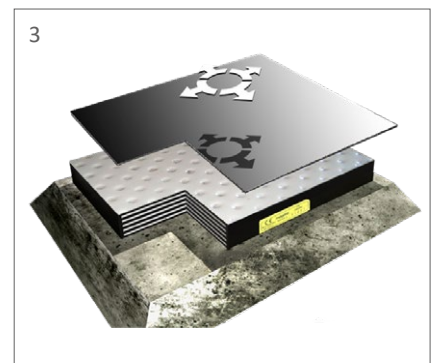
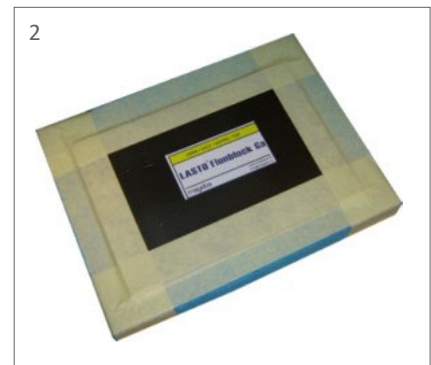
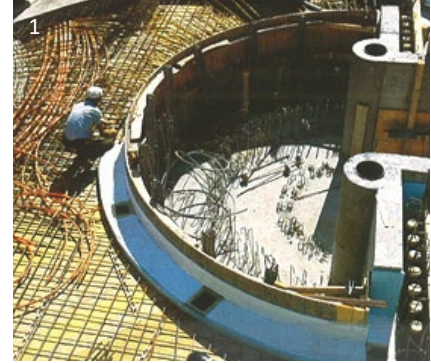

- 1 Installation as a sliding point bearing
- 2 LASTO®FLONBLOCK Type D
- 3 A high-quality knuckle and sliding point bearing for low-friction load transmission to the supporting structure

Load and dimensions table

Bearing design

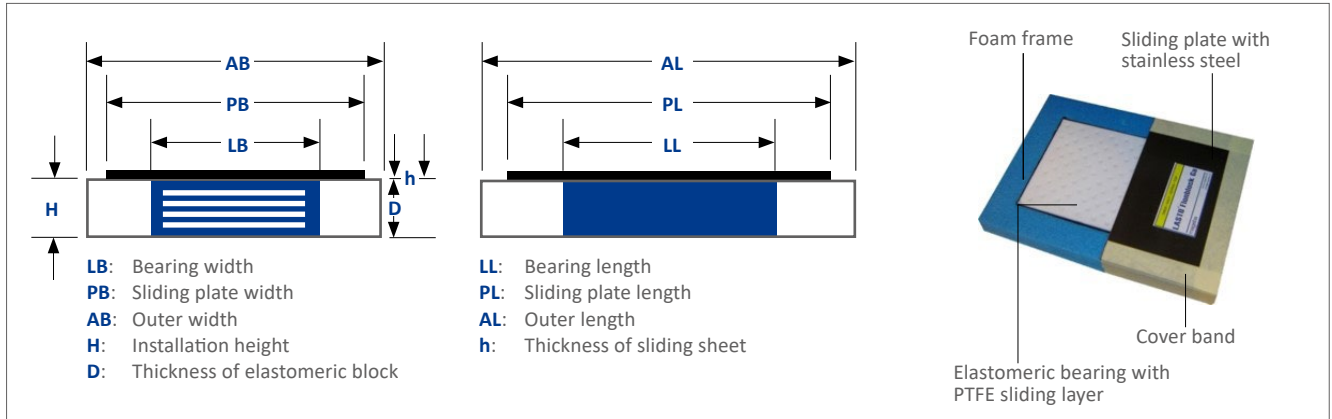

Technical data

Load		Rotation angle	Elastomeric block			Sliding sheet			Installation dimensions		
Fzd	Fz_min	Alpha_ab	LB	LL	D	PB	PL	h	AB	AL	H
[kN]	[kN]	[%]	[mm]	[mm]	[mm]	[mm]	[mm]	[mm]	[mm]	[mm]	[mm]
119	40	3.4	100	150	30	170	220	2	200	250	32
86	40	6.4	100	150	41	170	220	2	200	250	43
180	53	2.1	100	200	30	170	270	2	200	300	32
130	53	4.7	100	200	41	170	270	2	200	300	43
564	82	0.1	150	200	30	220	270	2	250	300	32
408	82	2	150	200	41	220	270	2	250	300	43
320	82	4	150	200	52	220	270	2	250	300	54
779	104	0	150	250	30	220	320	2	250	350	32
564	104	1.4	150	250	41	220	320	2	250	350	43
442	104	2.8	150	250	52	220	320	2	250	350	54
1,004	125	0	150	300	30	220	370	2	250	400	32
727	125	1	150	300	41	220	370	2	250	400	43
570	125	2.1	150	300	52	220	370	2	250	400	54
1,235	140	0.1	200	250	41	270	320	2	300	350	43
967	140	1.3	200	250	52	270	320	2	300	350	54
795	140	2.5	200	250	63	270	320	2	300	350	65
675	140	3.8	200	250	74	270	320	2	300	350	76
1,612	169	0.1	200	300	41	270	370	2	300	400	43
1,263	169	1	200	300	52	270	370	2	300	400	54
1,039	169	2	200	300	63	270	370	2	300	400	65
882	169	3	200	300	74	270	370	2	300	400	76
2,004	197	0	200	350	41	270	420	2	300	450	43
1,571	197	0.8	200	350	52	270	420	2	300	450	54
1,291	197	1.6	200	350	63	270	420	2	300	450	65
1,096	197	2.4	200	350	74	270	420	2	300	450	76
2,408	226	0	200	400	41	270	470	2	300	500	43



Technical details and installation

Load		Rotation angle	Elastomeric block			Sliding sheet			Installation dimensions		
Fzd	Fz_min	Alpha_ab	LB	LL	D	PB	PL	h	AB	AL	H
[kN]	[kN]	[%]	[mm]	[mm]	[mm]	[mm]	[mm]	[mm]	[mm]	[mm]	[mm]
1,887	226	0.6	200	400	52	270	470	2	300	500	54
1,551	226	1.3	200	400	63	270	470	2	300	500	65
1,317	226	1.8	200	400	74	270	470	2	300	500	76
2,395	212	0	250	300	41	320	370	2	350	400	43
2,293	212	0.1	250	300	52	320	370	2	350	400	54
1,885	212	1	250	300	63	320	370	2	350	400	65
1,601	212	1.8	250	300	74	320	370	2	350	400	76
1,391	212	2.7	250	300	85	320	370	2	350	400	87
3,215	285	0.1	250	400	41	320	470	2	350	500	43
3,215	285	0.3	250	400	52	320	470	2	350	500	54
2,862	285	0.6	250	400	63	320	470	2	350	500	65
2,430	285	1.1	250	400	74	320	470	2	350	500	76
2,111	285	1.7	250	400	85	320	470	2	350	500	87
3,352	344	0	300	400	57	370	470	2	400	500	59
2,638	344	1	300	400	73	370	470	2	400	500	75
2,151	344	2.1	300	400	89	370	470	2	400	500	91
1,815	344	3.3	300	400	105	370	470	2	400	500	107

Bearings for load and displacement ranges other than those given here can be requested from us at any time.

Standards and external quality control

The LASTO®FLONBLOCK elastomeric bearings described in this document conform with the European standard EN 1337-3 and have successfully passed all tests required for the CE mark.

In addition to internal quality control, LASTO®FLONBLOCK elastomeric bearings are also regularly monitored in accordance with regulations by MPA Stuttgart, an independent supervisory board officially recognised in the field of construction. The role of external quality control is to monitor our own internal quality control procedures and our compliance with the requirements stipulated in the EN1337-3 standard. This external quality control complies with the regulations of the European standard EN 1337 and is a further

guarantee of the consistent high quality of mageba products.

LASTO®FLONBLOCK elastomeric bearings can also be delivered with static certification according to other standards, for example, DIN 4141, BS5400 or AASHTO.

Friction values

The friction values generated by horizontal displacement are dependent on the pressures acting on the sliding surfaces. The PTFE layer of the LASTO®FLONBLOCK bearing is equipped with lubrication slots filled with lubricant. This makes the friction values low, and they decrease with increasing pressure.

The following friction coefficients can be used for dimensioning the construction:

Pressure	Friction coefficient	Note
5 N/mm ²	0.047	Intermediate values can be extrapolated.
10 N/mm ²	0.04	
15 N/mm ²	0.033	



1 Plate with CE mark

Technical details and installation

Displacement

The standard displacement for the LASTO®FLONBLOCK Type D sliding bearing is ± 25 mm in the longitudinal and transverse directions. The installation dimensions of the finished bearing can be freely chosen from within certain limits, but they must be at least as big as the dimensions of the sliding plate. To ensure that the bearing does not move on its base, a minimum pressure of 3.0 N/mm^2 is required.

Torsion of the bearing surfaces

Deflection of the superstructure and/or imprecise dimensions during installation cause torsion of the bearing surfaces. The angle of rotation of the bearing must not exceed the angle stipulated in the dimensions sheet.

Unlike insitu concrete construction methods, where the bearing is always free of rotation during concreting, when using prefabricated construction in precast concrete and/or steel it is necessary to take into account that rotations will be transmitted to the bearing as soon as the precast concrete unit or steel girder is fitted. For these circumstances, a suitable safety margin must be added to the calculated angle of rotation of the bearing given in the table.

Installation instructions

LASTO®FLONBLOCK sliding bearings are delivered ready for installation and must not be opened as this will ruin the long-term dust-protection for the sliding sheet. The bearings are placed without anchoring on a smooth, flat mortar bed (cement mortar with high compressive strength). The mortar bed must be at least 30mm larger than the LASTO®FLONBLOCK bearing on all sides.

The edge distances to the bearing core should be at least 50 mm on all sides. When inserting the bearing, it is important to ensure that it is installed horizontally.

The sliding plates are inserted or cast into the structure in such a way so as to ensure that their sliding surfaces are flush with the exterior concrete surfaces of the structure.

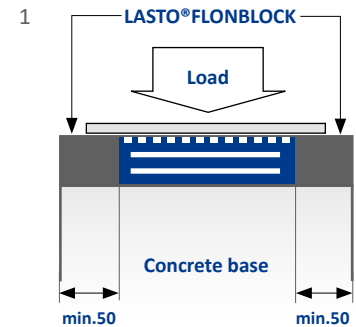

- 1 Edge distances from load-bearing core min. 50 mm
- 2 LASTO®FLONBLOCK Type D



Structural bearings

Tender texts

Example of tender text

Delivery and installation of an installation-ready, free-sliding PTFE sliding point bearing with a 2mm stainless steel sliding plate.

Type: LASTO®FLONBLOCK Type D

Displacement: ± 25 mm

Load (N_d): 180 kN

Core (LB x LL x D): 100 x 200 x 30 mm

Sliding plate (PB x PB x h): 210 x 260 x 2 mm

Installation size (AB x AL x H): 230 x 280 x 32 mm

Supplier:

mageba sa

Solistrasse 68

CH-8180 Bülach

Tel.: +41-44-872 41 52

Email: buildings.ch@mageba-group.com

www.mageba-group.com

Project references



Tunnel Mont Terri St., (FR)



Paul Klee Institut, (CH)



Swing, (CH)



Freeway overpass
Moosgasse, (CH)

Product groups (building construction)



Structural bearings



Vibration isolation

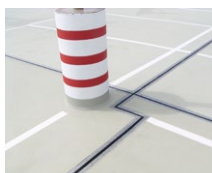

Expansion joints

mageba
mageba-group.com

engineering connections®