

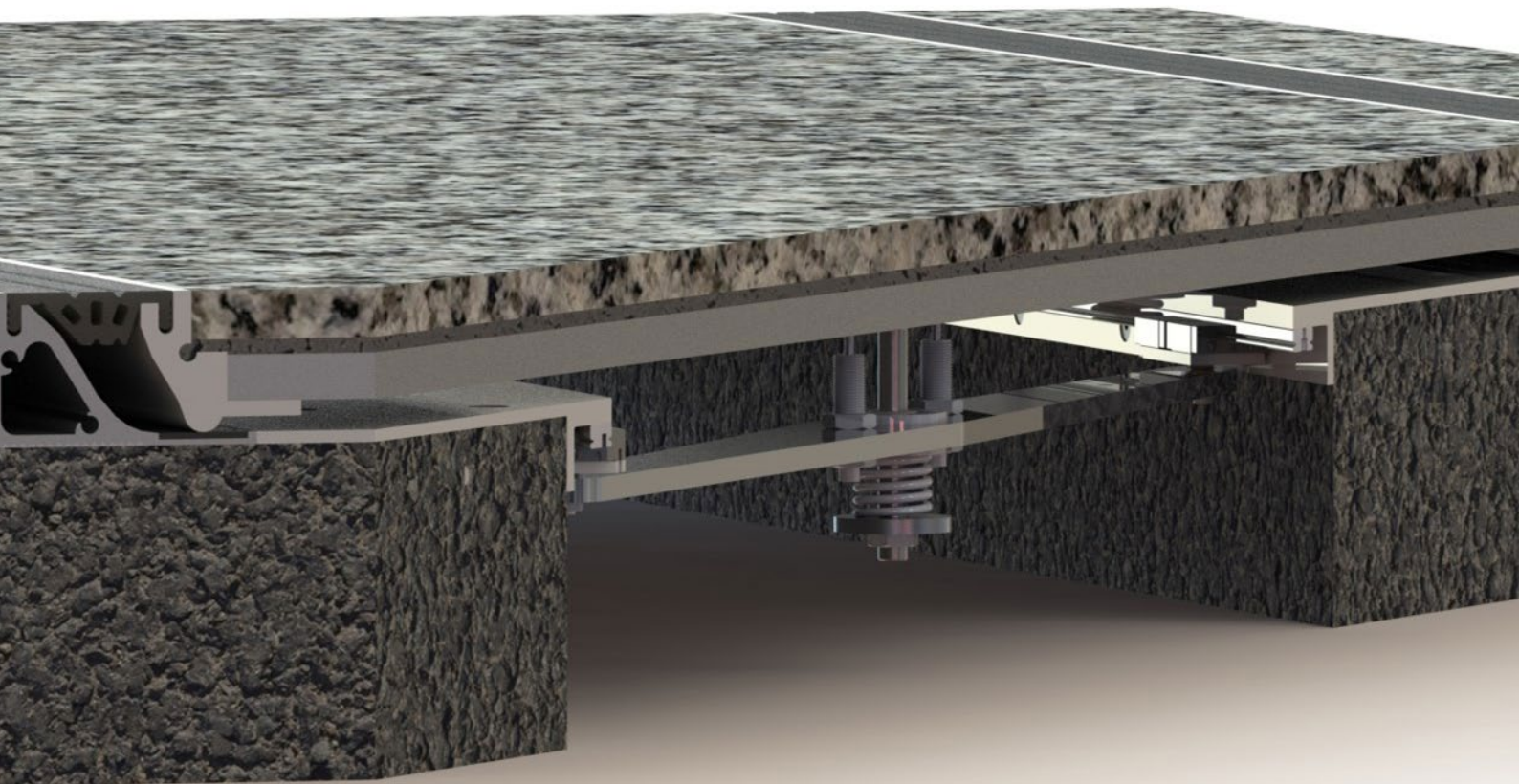

Expansion joints

Infrastructure | Buildings | Industrial structures

mageba seismic joints for buildings – for performance, safety and comfort



TENSA[®]QUAKE Type D and Type S

earthquake resilient, durable, watertight

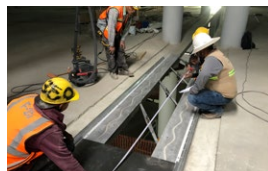
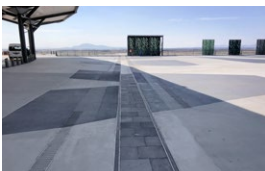



Integrated approach for seismic protection

Modern earthquake engineering

Strategically important buildings such as hospitals and other emergency services must continue to serve their purpose in the aftermath of an earthquake. At the same time, other important buildings such as airports, schools, public buildings, essential factories, oil & gas structures, power plants, office buildings etc., must be designed earthquake-resistant in order to protect the people, as well as to minimize economic losses.

Continuously improving earthquake engineering knowledge, in combination with modern technology, allows structures and its users to be safe from fatal consequences even in case of severe earthquakes.

Energy dissipation and seismic isolation, or a combination of both, are nowadays common seismic protection practices.

The objective of seismic isolation is to decouple the building from the ground, to prevent seismic damage of structural elements such as columns and beams from absorbing the earthquake energy.

Energy dissipation is achieved mostly by use of viscous dampers and is a good practice for high-rise buildings. At the same time, viscous dampers reduce high-frequency vibrations notably coming from wind.

In a seismically isolated building, the entire superstructure is supported on separate seismic isolators whose dynamic characteristics are designed to decouple the ground motion. Some isolators are also designed to add substantial damping. Displacement and yielding are concentrated at the level of the isolation devices, and the superstructure behaves very much like a rigid body. Some of the commonly used isolation systems are laminated or high-damping rubber bearings (LRB or HDRB) and friction pendulum bearings (FPB).

Interaction of seismic devices

An integrated approach for safe seismic design of structures is essential. A certain freedom of movement between the building and the ground, or among the different parts of the building, needs to be allowed for, in particular for base-isolated structures. This is achieved by gaps or moats, which in turn, present a challenge for the building's serviceability: the gaps must be covered by seismic joints, to allow a safe and comfortable passage for the building's users.

Most conventional building seismic joints are not suitable solutions, as they are not designed for three-dimensional, large and fast seismic movements.

Specially designed seismic joints are needed. To understand the specific load and movement characteristics, such as displacements, velocity and off-sets after an earthquake, it is key to have a deep understanding of the overall seismic design of the structure itself, and how the seismic joints interact with the other seismic devices such as base-isolators and dampers.

mageba's seismic expertise

Building on the expertise and experience of the most advanced seismic devices, installed on hundreds of structures around the world, mageba engineers are the owners and designers' best partners to define an integrated seismic protection strategy for the specific conditions and requirements of the structure.

mageba can help to select at early project stage the most suitable products from a wide range of base-isolation bearings, viscous dampers, seismic joints and earthquake monitoring systems, to ensure that they interact effectively among each other as well as with the structure itself.

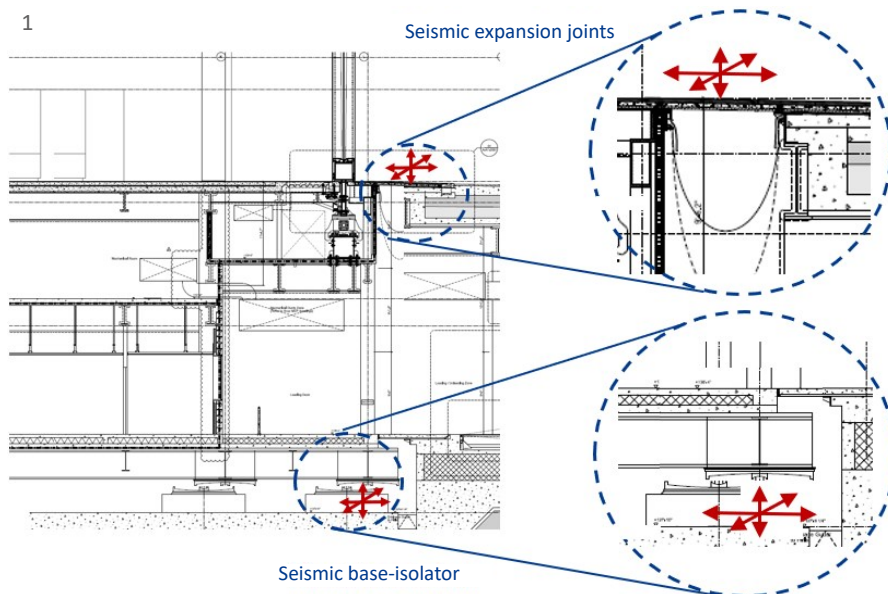

- 1 Interaction of seismic joints with base-isolators
- 2 Seismic joint in neutral (service stage) position
- 3 Seismic joint in open position
- 4 Seismic joint in closed, pop-out position
- 5 Seismic joint with vertical displacement

Product characteristics

Principle

The mageba TENSA®QUAKE seismic joint system has been developed for use inside and outside of buildings in seismically active areas. The design was made in a way to ensure the proper functionality in interaction with other structural members, in particular, other seismic devices.

In addition to functional requirements, for buildings of high architectural standards, the TENSA®QUAKE seismic joints integrate into the building environment in a subtle and elegant manner.

Movement capacities

TENSA®QUAKE seismic joints are designed to accommodate very large seismic (or wind) movements, both longitudinal and transverse, as well as to accommodate vertical movements as occur at base-isolated buildings. A series of typical movement ranges is provided on the next pages. However, larger movements or movements between the indicated ranges are available on request. TENSA®QUAKE seismic joints have already been manufactured to facilitate both, longitudinal and transverse movements of up to 2,600 mm.

Load bearing capacities

TENSA®QUAKE seismic joints are suitable for various load categories, ranging from pedestrian, to light-vehicles (cleaning equipment, scissor lifts etc.), to heavy-vehicles (cars, buses etc.). To keep the flexibility high for global use, and to meet the individual projects' requirements, there is no specific national standard applied to the system. Instead, a proof calculation is made for each specific project to confirm compliance with the specifications.

This seismic joint type was designed for use inside or around buildings, not for high-velocity traffic such as is the case for example on bridges; for bridge applications, mageba has other specialized seismic and non-seismic products.

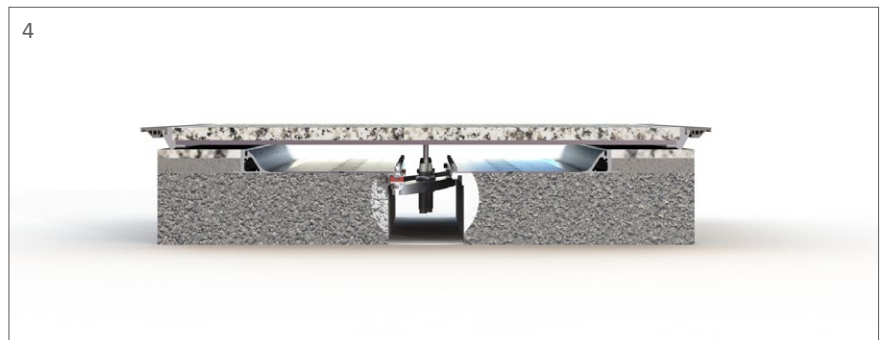
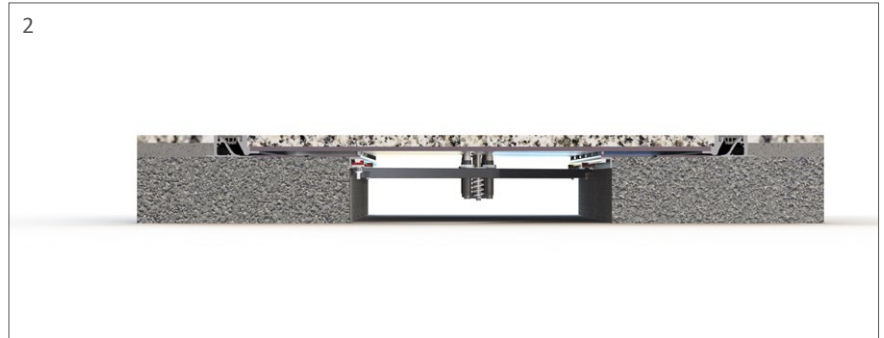



Expansion joints

Product features and materials

Engineered to survive

The TENSA®QUAKE seismic joint is designed to protect the building, as well as the seismic joint itself, from damage during an earthquake. Key components for this are the low impact pop-out ramps and the guided damping center-devices. Both features are unique in their design and set new standards in the industry.

To demonstrate the integrity of the design, not only conceptually but also under seismic action, a series of dynamic tests on full-scale prototypes were successfully performed.

Architectural features

Great attention was given to combine engineering functionality with architectural aesthetics. In principle, despite the very large movement capacity, only a very small portion of the TENSA®QUAKE seismic joint can be seen once installed. Many kinds of floor finishes can be integrated onto the joint (such as marble, granite, wood, vinyl, concrete etc.).

Safety and convenience

The floor-flush design ensures a high level of comfort for pedestrians and vehicles when crossing the seismic joints, and there is no tripping hazard from a step on a sliding plate. The design is compliant with ADA requirements.

TENSA®QUAKE seismic joints are watertight at the surface, by using rubber seals installed between the profiles. An additional vapor barrier can be added underneath the joint to serve as a second line of defense.

Blanket-type fire barriers can also be integrated into the TENSA®QUAKE seismic joints.

Materials

Most parts are made of aluminum 6063-T6 (ASTM B221 and B209 / EN 573-3). Exposed surfaces are anodized.

For joints with higher loads or movements, the main cover plates may be made of hot-dip galvanized carbon steel Grade 36 / S235 (ASTM A36 / EN10025-2) or stainless steel 316L / 1.4404 (AISI 316 / EN10088-3).

The rubber seals are EPDM or other rubber materials as requested. The standard color is black, but other colors are also possible.

mageba's high wear-resistant and low-friction ROBO®SLIDE sliding material is used for the sliding strip.

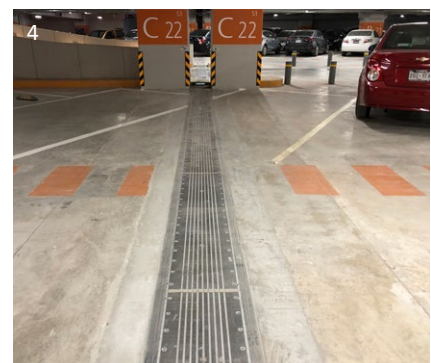
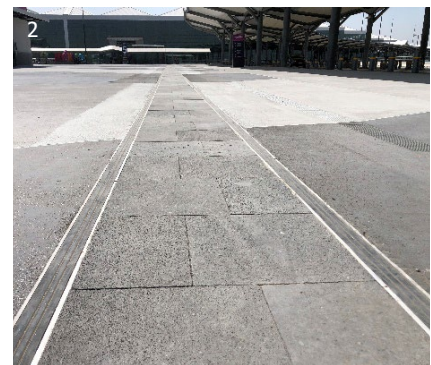

- 1 Seismic joint in a pedestrian area
- 2 Seismic joint in a patio area
- 3 Seismic joint in an entrance area
- 4 Seismic joint in a car park area

Typical areas of application

- Airport buildings
- Railway & subway stations
- Car parks
- Hospitals
- Fire stations
- Factories and warehouses
- Sports stadiums
- Exhibition Centers
- Shopping malls
- Hotels
- Office & public buildings
- Residential buildings

Testing and verification

System performance verification testing

Dynamic and kinematic behavior of expansion joints during earthquakes can be simulated by modelling to some extent. However, computer simulations have limits and cannot replace a full-scale test of the seismic joint system under simulated earthquake conditions.

In order to verify the actual performance of seismic devices, it is recommended - and according to some national standards required - to perform prototype testing.

However, there is little guidance from national standards regarding performance testing of seismic joints, so mageba partnered with some of the world-wide leading experts and testing laboratories to establish suitable testing protocols, and practical application of the tests.

Testing procedures were established based on Caltrans specifications for seismic testing, EN 15129 and ASTM E1399. Tests were performed at the State Key Laboratory for Disaster Reduction in Civil Engineering (SLDRCE) of Tongji University, China, and Sismalab Material Research and Testing Center, China.

Several series of uni- and bi-axial, cyclic longitudinal and transversal movement tests at various displacement and velocity ranges were successfully performed on both TENSA®QUAKE Types, D and S.

This comprehensive testing campaign has demonstrated full performance verification under service and seismic conditions which provides our clients total peace of mind when choosing TENSA®QUAKE seismic joints.

- 1 Testing of TENSA®QUAKE Type S at Tongji University, Shanghai, according to Caltrans test procedure. Full longitudinal and transversal $\pm 1,320$ mm and ± 127 mm vertical seismic movements; 10 consecutive cycles at 1.3 m/s
- 2 Testing of TENSA®QUAKE Type D at Sismalab Material Research and Testing Center, Shanghai, according to EN 15129 movement amplitude and velocity requirements. Full longitudinal and transversal ± 450 mm seismic movements; 3 consecutive cycles at 0.3 m/s. Verifications according to ASTM E1399, Seismic Class III.
- 3 Verification of seismic ramp profile performance and seal pull-out characterization
- 4 Typical force and displacement graph of a Type D joint, with peak forces at ramp impact
- 5 Typical force-displacement diagram of a cycling testing

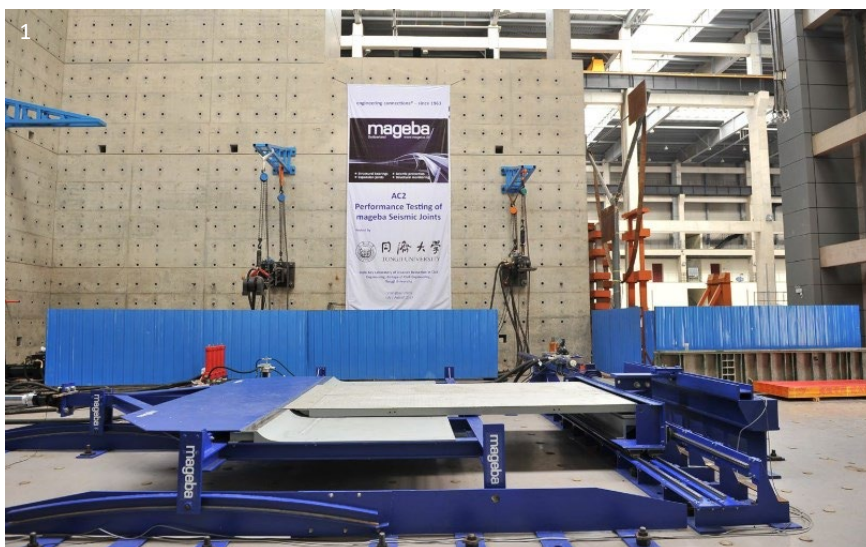
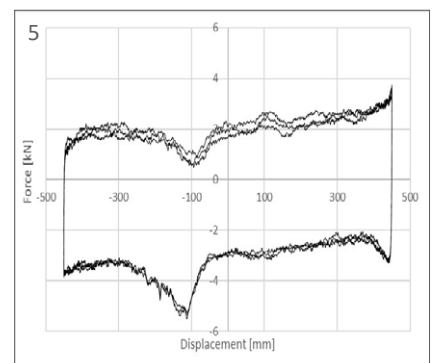
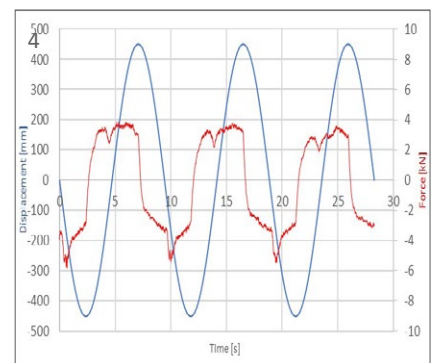



Design and movement capacity Type D

Design Principles

TENSA®QUAKE Type D seismic joints have the ability to accommodate multi-directional service and seismic movements. The main cover plate is held in the center position by the damping turn-bar system during opening and closing of the joint.

In service condition, the cover plate slides on a ROBO®SLIDE high-wear resistant and low-friction sliding strip.

In the event of seismic movements, when opening longitudinally, the cover plate slides over the substructure adjustable finger plates. When closing longitudinally, the cover plates pops out by sliding up the ramp profile. Upon re-opening, the cover plate returns safely to the center position through the damping turn-bar system.

When transversal seismic movements occur, the cover plate simply slides along the ramp profiles. This can be in any longitudinal opening or closing position.

Application of Type D

TENSA®QUAKE Type D joints are typically used for floor-to-floor connections. The double-sided pop-out mechanism splits the movement into two, which reduces the space needed on each side of the slab.

Type D joints work particularly well for buildings with independent, seismically isolated modules.

Several horizontal layout situations, such as corners, X- and T-intersections, can be accommodated.

Movement Capacity and Dimensions

The table below shows typical movement capacities and dimensions of a standard series. In many cases, however, standard size ranges do not fit the design needs of a specific building. Based on our extensive experience and expertise with seismically isolated buildings, we can provide tailor-made solutions for TENSA®QUAKE Type D joints.

- ① Ramp profile
- ② Sliding profile
- ③ Cover plate
- ④ Rubber seal
- ⑤ Adjustable finger plates
- ⑥ ROBO®SLIDE sliding strip
- ⑦ mageba damping turn-bar system

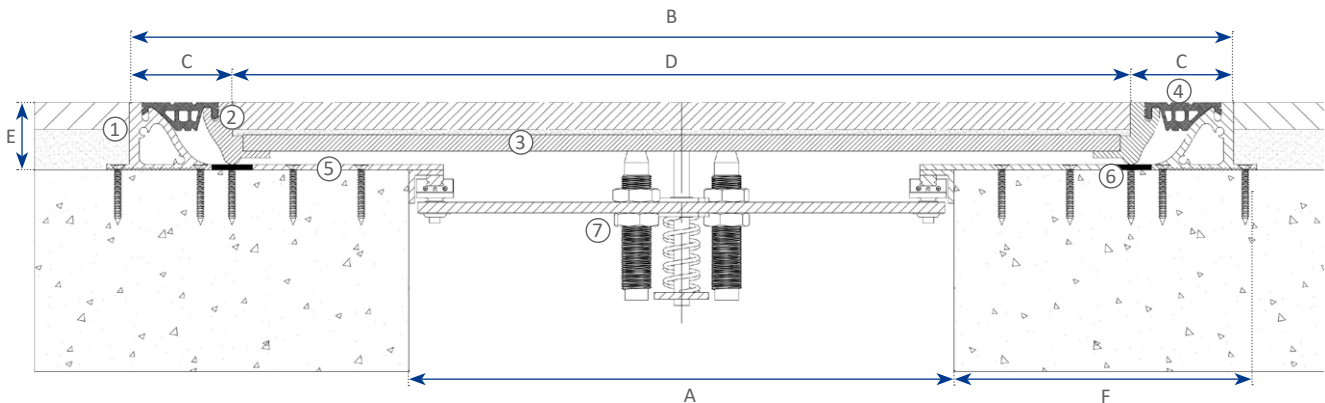

Type	Min. gap width (can vary) A		Service movement (Longitudinal & transversal)		Seismic movement (Longitudinal & transversal)		Joint width B		Visible width C		Infill width D		Blockout height E		Blockout width F	
	in	mm	in	mm	in	mm	in	mm	in	mm	in	mm	in	mm	in	mm
100-D	8"	200	±¾"	±20	±2"	±50	16"	420	3"	75	10"	270	2"	50	5"	130
200-D	10"	250	±¾"	±20	±4"	±100	20"	520	3"	75	14"	370	2"	50	6"	155
300-D	12"	300	±¾"	±20	±6"	±150	24"	620	3"	75	18"	470	2"	50	7"	180
400-D	14"	350	±¾"	±20	±8"	±200	28"	720	3"	75	22"	570	2"	50	8"	205
500-D	16"	400	±¾"	±20	±10"	±250	32"	820	3"	75	26"	670	2"	50	9"	230
600-D	18"	450	±¾"	±20	±12"	±300	36"	920	3"	75	30"	770	2"	50	10"	255
700-D	20"	500	±¾"	±20	±14"	±350	40"	1,020	3"	75	34"	870	2"	50	11"	280
800-D	22"	550	±¾"	±20	±16"	±400	44"	1,120	3"	75	38"	970	2"	50	12"	305
900-D	24"	600	±¾"	±20	±18"	±450	48"	1,220	3"	75	42"	1,070	2"	50	13"	330
1000-D	26"	650	±¾"	±20	±20"	±500	52"	1,320	3"	75	46"	1,170	2"	50	14"	355
1100-D	28"	700	±¾"	±20	±22"	±550	56"	1,420	3"	75	50"	1,270	2"	50	15"	380
1200-D	30"	750	±¾"	±20	±24"	±600	60"	1,520	3"	75	54"	1,370	2"	50	16"	405
1300-D	32"	800	±¾"	±20	±26"	±650	64"	1,620	3"	75	58"	1,470	2"	50	17"	430
1400-D	34"	850	±¾"	±20	±28"	±700	68"	1,720	3"	75	62"	1,570	2"	50	18"	455
1500-D	36"	900	±¾"	±20	±30"	±750	72"	1,820	3"	75	66"	1,670	2"	50	19"	480

Larger movements or movements between the indicated ranges are available. Vertical service and seismic movement for all types is ±15mm.

Design and movement capacity Type S

Design Principles

TENSA®QUAKE (Type S) seismic joints have the ability to accommodate multi-directional service and seismic movements. The main cover plate is fixed on one side and is sliding on the other side during opening and closing of the joint.

In service condition, the cover plate slides on a ROBO®SLIDE high-wear resistant and low-friction sliding strip.

In the event of seismic movements, when opening longitudinally, the cover plate slides over the substructure adjustable finger plates on one side only, as the sliding plate has a fixed pivoting connection on the other side. When closing longitudinally, the cover plates pops out by sliding up the ramp profile. The cover plate returns safely to the center position after the movement.

When transversal seismic movement occurs, the cover plate simply slides along the ramp profile on the moveable side.

Application of Type S

TENSA®QUAKE Type S joints are used for both floor-to-(fixed)floor and floor-to-wall connections. Typically, this Type S joint is used when one side is not base-isolated and thus, is fixed (e.g. the ground surrounding the building). The full movement is then occurring on the moveable side of the joint.

Various horizontal layout situations, such as corners, X- and T-intersections, can be accommodated, but need special considerations to avoid interference of one plate with another.

Movement Capacity and Dimensions

The table below shows typical movement capacities and dimensions of a standard series. In many cases, however, standard size ranges do not fit the design needs of a specific building. Based on our extensive experience and expertise with seismically isolated buildings, we can provide tailor-made solutions for TENSA®QUAKE Type S joints.

- ① Ramp profile
- ② Fixed profile
- ③ Sliding profile
- ④ Rotation profile
- ⑤ Cover plate
- ⑥ Rubber seal moving side
- ⑦ Rubber seal fixed side
- ⑧ Adjustable finger plate
- ⑨ ROBO®SLIDE sliding strip

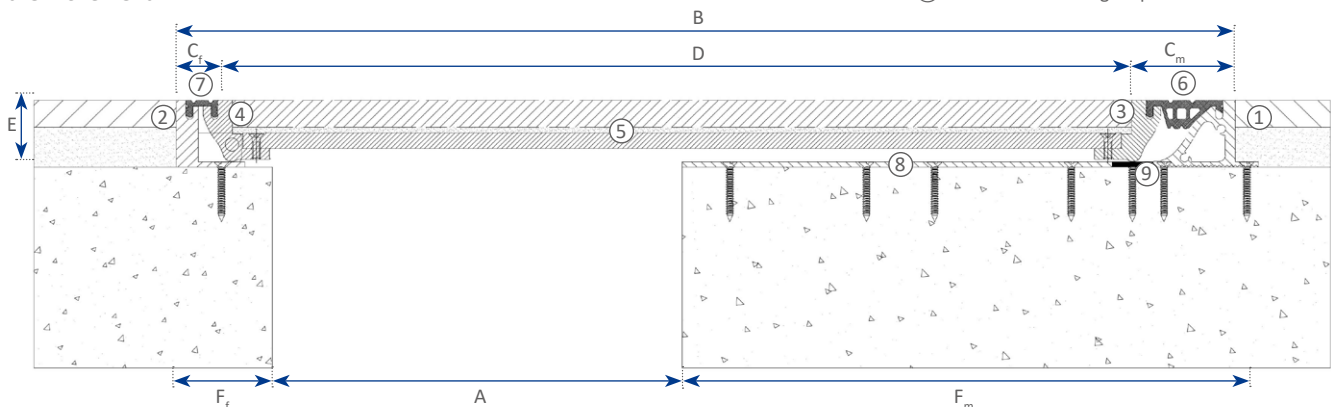

Type	Min. gap width (can vary) A		Service movement (Longitudinal & transversal)		Seismic movement (Longitudinal & transversal)		Joint width B		Visible width C _i		Visible width C _m		Infill width D		Blockout height E		Blockout width F _f		Blockout width F _m	
	in	mm	in	mm	in	mm	in	mm	in	mm	in	mm	in	mm	in	mm	in	mm	in	mm
100-S	2"	50	±3/4"	±20	±2"	±50	10"	265	1.5"	40	3"	75	6"	150	2"	50	3"	75	6"	160
200-S	4"	100	±3/4"	±20	±4"	±100	14"	365	1.5"	40	3"	75	10"	250	2"	50	3"	75	8"	210
300-S	6"	150	±3/4"	±20	±6"	±150	18"	465	1.5"	40	3"	75	14"	350	2"	50	3"	75	10"	260
400-S	8"	200	±3/4"	±20	±8"	±200	22"	565	1.5"	40	3"	75	18"	450	2"	50	3"	75	12"	310
500-S	10"	250	±3/4"	±20	±10"	±250	26"	665	1.5"	40	3"	75	22"	550	2"	50	3"	75	14"	360
600-S	12"	300	±3/4"	±20	±12"	±300	30"	765	1.5"	40	3"	75	26"	650	2"	50	3"	75	16"	410
700-S	14"	350	±3/4"	±20	±14"	±350	34"	865	1.5"	40	3"	75	30"	750	2"	50	3"	75	18"	460
800-S	16"	400	±3/4"	±20	±16"	±400	38"	965	1.5"	40	3"	75	32"	850	2"	50	3"	75	20"	510
900-S	18"	450	±3/4"	±20	±18"	±450	42"	1,065	1.5"	40	3"	75	36"	950	2"	50	3"	75	22"	560
1000-S	20"	500	±3/4"	±20	±20"	±500	46"	1,165	1.5"	40	3"	75	40"	1,050	2"	50	3"	75	24"	610
1100-S	20"	550	±3/4"	±20	±20"	±550	50"	1,265	1.5"	40	3"	75	44"	1,150	2"	50	3"	75	26"	660
1200-S	20"	600	±3/4"	±20	±20"	±600	54"	1,365	1.5"	40	3"	75	48"	1,250	2"	50	3"	75	28"	710
1300-S	20"	650	±3/4"	±20	±20"	±650	58"	1,465	1.5"	40	3"	75	52"	1,350	2"	50	3"	75	30"	760
1400-S	20"	700	±3/4"	±20	±20"	±700	62"	1,565	1.5"	40	3"	75	56"	1,450	2"	50	3"	75	32"	810
1500-S	20"	750	±3/4"	±20	±20"	±750	66"	1,665	1.5"	40	3"	75	60"	1,550	2"	50	3"	75	34"	860

Larger movements or movements between the indicated ranges are available. Vertical service and seismic movement for all types is ±15mm.



Technical advantages

Technical advantages

Based on our profound understanding of the performance requirements from the seismic joints under dynamic conditions, as well as under normal service, mageba has incorporated several features into the TENSAR[®]QUAKE seismic joints that provide advantages over standard types of expansion joints. This results in a seismic joint that prevents the joint itself, as well as the adjacent structure, from incurring damage, which ensures full functionality after an earthquake.

Low impact pop-out ramp

The TENSAR[®]QUAKE seismic joint profiles are engineered and tested for optimized seismic behavior.

The specially designed ramp and sliding profiles consider the typical movements from seismically isolated structures and allow lower impact loads at high velocities as well as vertical acceleration reduction, following the speed bumps impact analysis. This results in the lowest possible impact stresses and thus, avoids damage during an earthquake to both, the seismic joint itself, as well as the building in general.

This innovative, patented solution with a gradually curved geometry – as opposed to typically linear and straight ramp systems - is setting a new state-of-the-art performance for seismic joints.

Guided damping center-device

The guided damping center-device is a key component for a well-functioning, durable seismic joint.

Based on the extensive experience with dynamics and kinematics of expansion joints in other applications, mageba has engineered a center-device that allows fully guided movement and load transfer in both, service and seismic conditions. Key elements are:

- Guided sliding rail-bearings on both sides, to prevent the turn-bar from locking up during fast seismic movements (no drawer-effect) and thus, to avoid damage.
- Guided center-pin, which connects the turn-bar with the sliding plate, to keep the seismic joint at service stage as well as during and after an earthquake centered. This pin is attached to a spring to dampen the impact and assure full contact after pop-out.
- Two dampers absorb the load impact during seismic pop-out as well as dampening vibrations from pedestrians and vehicles during service stage, improving the crossing comfort.

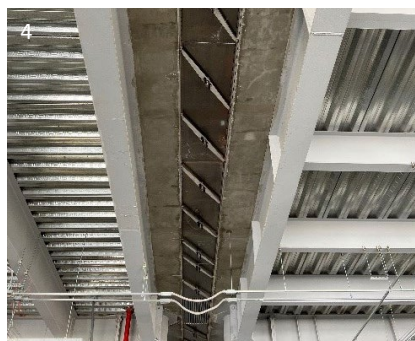
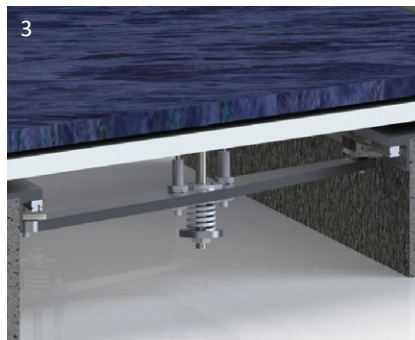
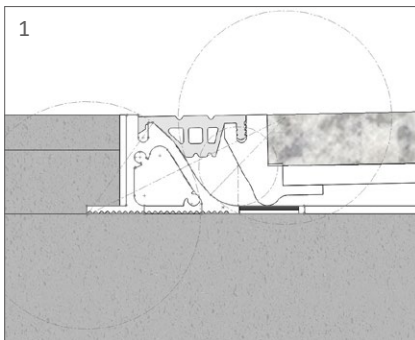

- 1 Gradually curved ramp and sliding profile system
- 2 Proof of concept through extensive testing
- 3 The mageba guided damping center-device
- 4 Guided damping center-device installed
- 5 ROBO[®]SLIDE low-friction & low-wear sliding material

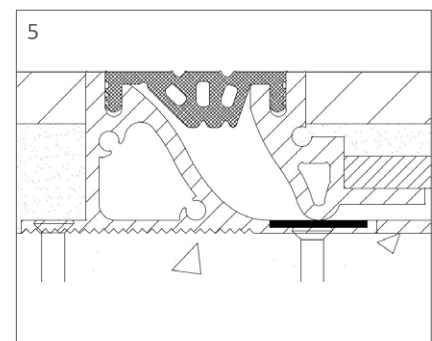
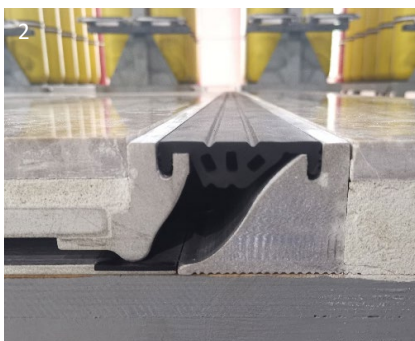

Client benefits

Low-friction & low-wear sliding material

The TENSAR®QUAKE seismic joint profiles comes with ROBO®SLIDE high grade sliding strip to assure smooth and noise-free service movements. As >99.99% of the movement of a seismic joint is non-seismic, a proper movement capability with low-friction and low-wear is critical for long-term durability and to avoid the ‘squeaking’ that can occur with metal-on-metal sliding solutions.

ROBO®SLIDE is a low-friction and low-wear sliding material used for bridge bearings and seismic pendulum bearings. It has been tested for 50 km cumulative sliding distance from -50°C up to 80°C. This makes ROBO®SLIDE maintenance-free for its full service life.

The use of a high-grade sliding material is important for seismic movements, too. Slip-stick effects such as occur without a proper sliding material must be avoided.

Floor-flush and watertight at surface

Extruded EPDM rubber seals assure watertightness at the surface, which prevents water from flowing into the movement gap (e.g. when the cleaning machine passes over the joint, or of course rain in outdoor applications). The rubber seals come in black color as a standard, but other colors are available on request to blend into the adjacent floor finish. In addition, the rubber seal’s shape is engineered to detach in a defined way to avoid damage during seismic movements, and to allow easy re-insertion after an earthquake.

The floor-flush design ensures a high level of comfort for pedestrians and vehicles when crossing the seismic joints. There is no tripping hazard due to a step on a sliding plate, and there is no bumping of suitcases or luggage carts. TENSAR®QUAKE seismic joints are compliant with ADA requirements.

Architectural and functional flexibility

The TENSAR®QUAKE seismic joint is esthetically appealing thanks to a very slim exposure of the profiles. Further, the joints are able to accommodate many floor finishes, such as marble, ceramic, wood, concrete, carpet, metal etc. This makes the seismic joint almost invisible, despite its large movement capacity.

At the same time, for instance if exposed to some light traffic such as in a car park area, the cover plate can be given an anti-skid surface. This is typically done with a machined profiling on the cover plate, but can also be achieved with a special anti-skid paint system or anti-skid tapes.

Overall, the TENSAR®QUAKE seismic joint system provides a great deal of flexibility to adjust parameters to match individual needs related to a specific project.

- 6 Long-durability testing of ROBO®SLIDE
- 7 Rubber seal does not damage during pop-out
- 8 Fully floor-flush finish
- 9 Seismic joints with a movement capacity of ±1,300 mm can be hardly seen
- 10 Posts for electronic identification integrated on seismic joints at a building entrance

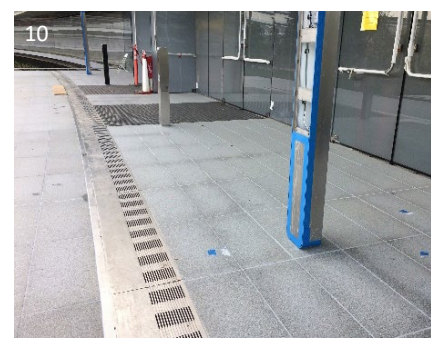
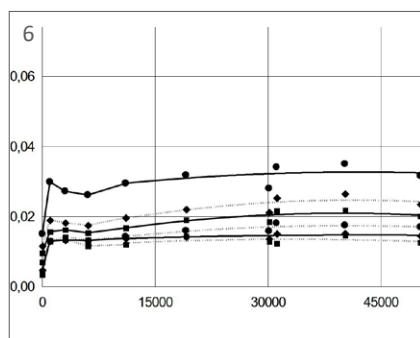



Installation and specialties

Installation

The main parts are pre-assembled in the factory, which makes the installation on site very straight-forward. There are no specialized people or tools needed, and the installation steps can be followed from a comprehensive installation manual.

If required, a mageba engineer can still provide training and supervision for installation. This can be in person on-site, or remotely through our innovative, digital installation supervision service. With the help of a head-mounted mini-tablet with video functionalities worn by a colleague on site, transmitting real-time video images, a mageba engineer or installation specialist at another location can efficiently train, oversee and coordinate the installation work, introducing a new era in terms of cost reduction, flexibility and environmental sustainability.

Specialties & Engineering

Ideally, seismic joints can be selected from a standard series of products. However, more often than not, there are specific project conditions that dictate that standard solutions are not appropriate.

mageba offers full technical support to help determine the optimal seismic joint type, considering all technical and economic aspects, in order to achieve the most appropriate and cost-effective solution. If needed, special solutions can be proposed by our engineers.

Special solutions may be needed in case of floor-to-wall connections, T-type or X-type crossing of joints, horizontal or vertical bends, areas where structural or non-structural elements obstruct the free movement of the joints in any direction, or if there are specific safety requirements beyond the normal standard.

Another specialty area are seismic joints for roofs. In most cases, there are complex geometries involved, as roof structures are seldom straight, but are sloped and have changes of direction.

This results in very complex movement requirements for the roof joints which go beyond the typical horizontal-transversal-vertical pattern. mageba uses 3D modeling to solve such complex geometries. Solutions are then digitally tested for their movement capabilities, and typically a full movement-range test is performed on a prototype in the test lab to verify performance.

In addition to complex geometries, the load cases change also. Wind-loads become predominant, so roof joints must be designed for dynamic uplift loads.

And finally, water-tightness becomes even more important, as roof joints are fully exposed to rain and wind.

- 1 Inspection of installed joints by mageba engineers
- 2 Installation of TENSA®QUAKE Type D seismic joints
- 3 Remote digital installation supervision
- 4 Hat-type roof seismic joint
- 5 Special solution for obstructed areas

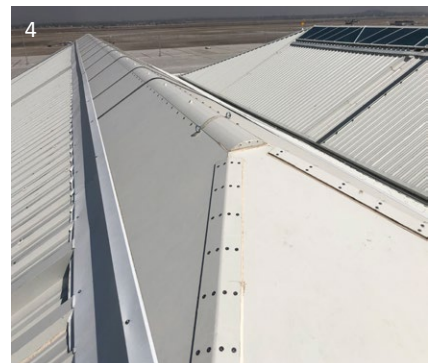

Case studies

AC 2 (California, USA)

The AC 2 project in California consists of a massive circular building with an area of over 26,130 m² and was designed to provide work space for 12,000 employees.

In 2016, TENSA®QUAKE seismic joints were supplied for 20 different locations with requirements to accommodate ±1,320 mm of movements in any horizontal directions as well as +127/-0 mm of vertical movements. mageba provided 700 m of joints for the pedestrian entrances, and 228m of heavy-duty joints for the vehicular entrances of this enormous building.

In addition to meeting demanding technical requirements the joints at the pedestrian entrances had to fulfill strict aesthetic requirements as well. mageba worked closely with both, the building and the landscape architects, to ensure that after installation the joints blended seamlessly with the surroundings.

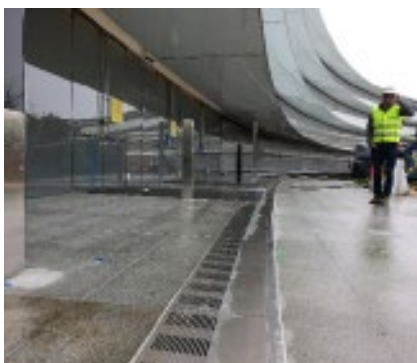

Car Park P6 Zurich Airport (Switzerland)

During an extension of Zurich airport, old car park buildings were torn down and replaced with a new, 12 floor parking building.

In order to meet the requirements in terms of seismic protection, the expansion features space of approximately 43 m to the existing building.

mageba was chosen to find a solution for a suitable passage construction. Besides seismic protection, adequate load and movement capacity had to be assured. The TENSA®QUAKE seismic joint was the optimal solution. 66 units of a total length of 451 m as well as steel cover plates of a total length of 2,013 m were delivered and installed.

Thanks to mageba's long-term experience in the infrastructure and building sector, the entire order processing to the point of installation was reliably carried out from one source and on schedule.

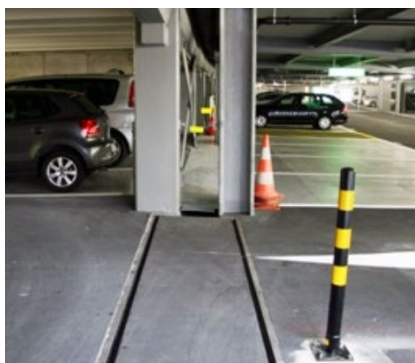

Felipe Angeles Intl. Airport (Mexico)

The Felipe Angeles International Airport (AIFA) is a new airport serving Mexico City and its metropolitan area. The project is located at the Santa Lucia Military Air-base, and it consist initially of a seismically isolated terminal with an area of 270,000 m². A second terminal is also planned to be built in the future as part of the airport's master plan. The terminal building is base-isolated with a total of 1,332 pcs. of RESTON®PENDULUM Duplo isolators, which were all supplied by mageba.

For this project, mageba supplied over 3,900 m of TENSA®QUAKE seismic floor and roof joints, providing the structure with the capability to move in any direction without interfering with the seismic isolation of the terminal. In addition, the implementation of the TENSA®QUAKE seismic joints also ensures the continuous operation of the airport terminal, even after a severe earthquake, due to its effective working principle and efficient recentering system.

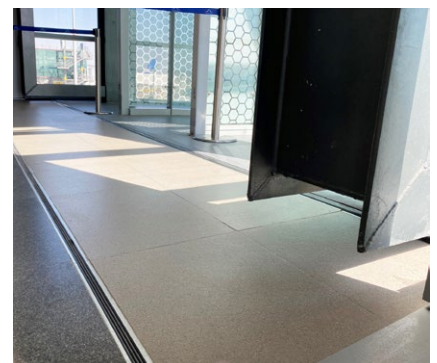



mageba seismic devices

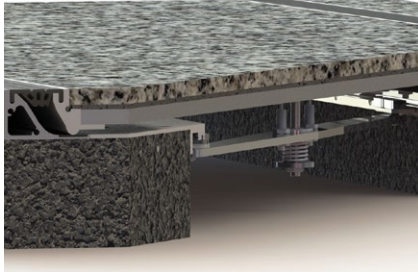

Seismic expansion joints



TENSA®QUAKE D and S

- Typical movements: Up to 2,600 mm
- Works as regular joint under normal conditions
- Increases movement capacity in case of an earthquake
- Perfect integration into different surfaces



Lead rubber bearings



LASTO®LRB

- For seismic isolation of structures
- Acts as regular bearing but allows large sudden movements
- Lead core deforms providing damping (up to 30%) and energy dissipation



High damping rubber bearings



LASTO®HDRB

- For seismic isolation of structures
- Acts as regular bearing but allows large sudden movements
- Special rubber used provides damping (up to 20%) and energy dissipation



Curved surface slider bearings



RESTON®PENDULUM

- For seismic isolation of structures
- Curved surfaces offer large periods
- Acts as regular bearing but allows large sudden movements
- Energy dissipation by friction
- Can be designed for very high loads and movements



Shock absorbers



RESTON®SA

- Protects from sudden dynamic loading & shocks
- Can be designed and optimized for less or more frequent actions
- Works in a wide range of temperatures
- Can work in parallel with anti-seismic isolators



Earthquake monitoring



ROBO®QUAKE

- Helps protect life and minimise loss of buildings use following an earthquake
- Real-time and historic information to a structure's response to seismic events
- Web- and mobile app based access
- Immediate alarm functions such as voice announcement, SMS and email notifications
- Real-time event intensity identification

Customer support

Our product specialists will be pleased to advise you in the selection of the optimal solution for your project, and to provide you with a quotation.

On our website, mageba-group.com, you will find further product information, including reference lists and tender documentation.