



Structural bearings

RESTON®POT bearings

Introduction

The following tables indicate the dimensions of standard RESTON®POT bearings with vertical load capacities of up to 75 MN. Minimum movement capacities, supplemental movements and minimum dimensions as specified by the standard EN 1337 are incorporated in the design. It should be noted that bearing heights can vary by up to 10 mm as a result of fabrication tolerances.

In determining bearing dimensions, assumptions were made as described below.

Load combinations

Bearings are dimensioned to resist the maximum vertical and horizontal forces indicated in the tables.

Maximum permissible horizontal loads are assumed to act only in combination with a simultaneously acting vertical load of approximately 40 % of maximum (with friction thus resisting some of the horizontal force). More demanding load combinations must be checked individually.

The relevant parameters are:

- N_{Rd} : Maximum vertical load capacity of the bearing (ULS)
- V_{Rd} : Maximum horizontal load capacity of the bearing (ULS), under a vertical load of 40 % of N_{Rd}
- $N_{d,min}$: Minimum required vertical load with a simultaneous horizontal load, V_{Rd} (ULS)

It is assumed that friction can be considered to resist some of the horizontal force (with the exception of railway bridges and seismic loading).

The load combinations are in accordance with EN 1991. If the design loads are not in accordance with this standard, detailed design will be carried out in accordance with the applicable norm (e.g. AASHTO, BS, SIA, etc.).

Concrete strength

The pressure acting on concrete main structures is calculated in accordance with EN 1992 (partial surface pressure). Design requirements are generally fulfilled if concrete of class C30/37 or higher is used and the load distribution area in the concrete structure is approximately 1.6 times the base area of the pot.

Movements

- TE bearings: Total longitudinal movement of 100 mm (+/- 50 mm)
- TA bearings: Total longitudinal movement of 100 mm (+/- 50 mm), and transverse movement of 40 mm (+/- 20 mm)

Bearings can also be designed for larger longitudinal and transverse movements. This requires the dimensions of the sliding plate, the height and the upper anchorage to be adapted. For longitudinally fixed TE bearings, the movement is normally reduced.

Support

Our product specialists are always ready to advise you in selecting the optimal solution for your project, and to provide you with quotations for supply.

You can also find further information at mageba-group.com and in the relevant product brochure.

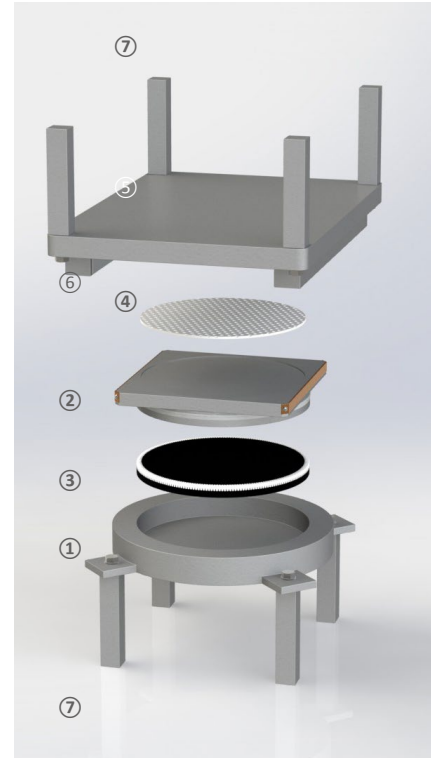

- 1 Steel pot
- 2 Piston
- 3 Elastomeric pad
- 4 PTFE sliding material (TE and TA bearings only)
- 5 Sliding plate (TE and TA bearings only)
- 6 Guide bars (TE bearings only)
- 7 Dowels or threaded sleeves (alternatively, anchor plates with shear studs can be supplied)



Typical dimensions – Type TF

RESTON®POT bearings of type TF resist horizontal forces in every direction and facilitate rotations about every axis. The bearing is connected to the superstructure and substructure by means of dowels or anchor plates with shear studs.

Bearing dimensions and weights for deviating requirements can be determined on request.

Dimensions for concrete class C30/37 (based on EN 1337)

Type	N _{rd}	V _{rd}	D	Without anchor plates			With anchor plates				
				N _{d,min}	H	Weight	N _{d,min}	Anchor plates*		H**	Weight
								Bo, Lu	Bu, Lo		
[kN]	[kN]	[mm]	[kN]	[mm]	[kg]	[kN]	[mm]	[mm]	[mm]	[kg]	
TF 1	852	280	200	323	80	30	315	220	310	112	45
TF 1.5	1,193	370	240	503	79	40	494	260	350	112	60
TF 2	1,706	460	280	683	79	50	672	300	390	112	75
TF 2.5	2,229	582	325	830	82	75	775	345	450	116	103
TF 3	2,935	705	365	976	87	90	878	390	510	119	130
TF 3.5	3,574	865	410	1,296	90	105	1,094	435	555	124	165
TF 4	4,496	1,034	455	1,634	95	130	1,310	480	600	128	200
TF 4.5	5,261	1,139	495	1,846	98	155	1,511	520	650	132	245
TF 5	6,388	1,247	540	2,060	100	180	1,711	560	700	136	290
TF 5.5	7,307	1,398	585	2,370	103	210	1,972	605	745	143	350
TF 6	8,647	1,556	625	2,678	111	250	2,232	650	790	149	410
TF 6.5	9,651	1,748	665	3,064	112	280	2,622	690	850	155	483
TF 7	11,207	1,905	710	3,376	122	345	3,012	730	910	160	555
TF 7.5	12,362	2,075	750	3,620	122	400	3,394	775	935	162	618
TF 8	14,143	2,263	795	3,878	126	450	3,775	820	960	164	680
TF 8.5	15,409	2,394	830	4,142	130	500	3,974	860	1,020	169	773
TF 9	17,422	2,526	875	4,404	136	570	4,172	900	1,080	174	865
TF 9.5	18,739	2,731	920	4,814	139	640	4,584	950	1,130	184	1,023
TF 10	20,986	2,938	975	5,228	151	780	4,996	1,000	1,180	193	1,180
TF 10.5	22,908	3,152	1,020	5,658	150	835	5,425	1,040	1,230	193	1,278
TF 11	24,942	3,367	1,060	6,086	151	890	5,854	1,080	1,280	193	1,375
TF 12	29,239	3,800	1,145	6,952	159	1,080	6,720	1,170	1,370	201	1,650
TF 13	33,807	4,395	1,225	8,142	174	1,345	9,710	1,250	1,510	222	2,120
TF 14	38,782	4,654	1,300	8,660	188	1,625	8,612	1,320	1,580	236	2,475
TF 15	44,098	4,850	1,380	9,052	188	1,800	8,820	1,400	1,660	237	2,770
TF 16	49,671	4,967	1,455	9,286	202	2,140	9,054	1,480	1,740	250	3,205
TF 17	55,665	5,010	1,530	9,372	216	2,525	9,140	1,550	1,810	262	3,715
TF 18	62,000	5,270	1,600	9,892	222	2,800	9,660	1,620	1,880	272	4,090
TF 19	68,577	5,486	1,680	10,324	223	3,055	10,092	1,700	1,960	273	4,460
TF 20	75,590	5,670	1,760	10,692	242	3,660	10,460	1,780	2,040	292	5,190

*) Bu, Bo: Widths of anchor plates, below and above; Lu, Lo: Lengths of anchor plates, below and above

**) Including anchor plates

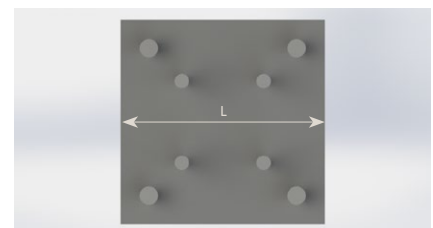
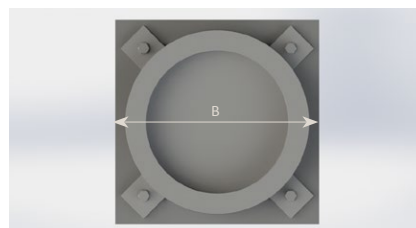
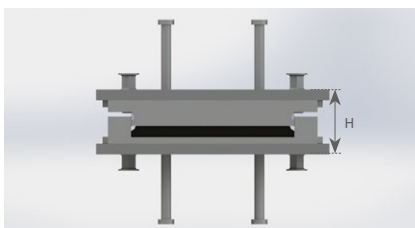
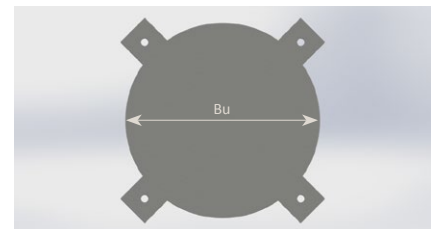
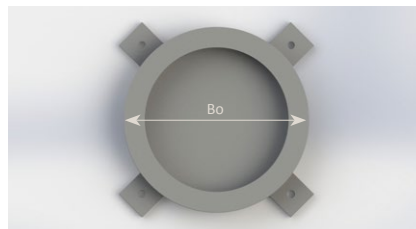
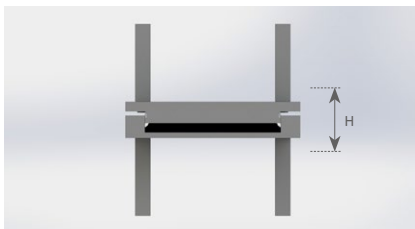

Section through TF bearing with dowels (without anchor plates)

Plan view of pot of a TF bearing

Plan view of piston of a TF bearing



Typical dimensions – Type TE

RESTON®POT bearings of type TE can move along one horizontal axis and resist horizontal forces transverse to that axis, while accommodating rotations about every axis. The bearing is connected to the superstructure and substructure by means of dowels or anchor plates with shear studs.

Small bearings are generally equipped with external guide bars (type “a”), for space reasons. Larger bearings are normally equipped with an internal guide bar along the bearing’s axis (type “i”). Depending on the size of the horizontal force in relation to the vertical force, bearings of intermediate size can be equipped with external or, as provided here, internal guide bars.

Bearing dimensions and weights for deviating requirements can be determined on request.

Dimensions for concrete class C30/37 (based on EN 1337)

Type	N _{Rd}	V _{Rd}	D	Without anchor plates					With anchor plates						
				N _{d,min}	H	B _x	B _y	Weight	N _{d,min}	Anchor plates*				H**	Weight
										Bu	Lu	Bo	Lo		
[kN]	[kN]	[mm]	[kN]	[mm]	[mm]	[mm]	[kg]	[kN]	[mm]	[mm]	[mm]	[mm]	[mm]	[kg]	
TE 1a	620	192	200	356	91	390	270	50	356	330	220	290	410	125	70
TE 1.5a	1,113	240	240	477	90	430	300	60	422	375	255	320	440	130	93
TE 2a	1,486	329	270	488	102	450	330	80	488	420	290	350	470	135	115
TE 2.5a	2,231	418	315	714	101	490	360	95	685	465	335	395	505	142	155
TE 3a	2,772	542	360	887	113	520	420	135	881	510	380	440	540	148	195
TE 3.5a	3,577	662	400	1,145	125	560	450	175	958	555	425	485	575	160	258
TE 4a	4,395	897	450	1,425	140	590	510	245	1,034	600	470	530	610	172	320
TE 4.5a	5,267	982	490	1,620	139	640	540	280	1,230	650	510	540	640	177	358
TE 5i	4,780	1,071	525	1,785	144	650	530	290	1,425	700	550	550	670	181	395
TE 5.5i	6,288	1,150	570	1,968	149	660	575	335	1,567	740	590	595	705	186	463
TE 6i	7,011	1,248	610	2,158	154	710	615	390	1,708	780	630	640	740	191	530
TE 6.5i	8,838	1,336	650	2,356	155	740	655	440	1,892	820	670	675	775	194	603
TE 7i	9,627	1,422	685	2,527	159	790	690	500	2,076	860	710	710	810	197	675
TE 7.5i	11,146	1,508	730	2,621	160	820	735	580	2,264	900	750	755	850	199	758
TE 8i	12,678	1,599	770	2,687	163	870	775	645	2,451	940	790	800	890	201	840
TE 8.5i	14,402	1,671	810	2,847	164	900	815	695	2,638	995	830	840	930	203	935
TE 9i	16,128	1,775	850	3,062	167	950	855	780	2,825	1,050	870	880	970	205	1,030
TE 9.5i	18,011	1,846	895	3,258	169	980	900	850	3,012	1,090	910	920	1,010	210	1,145
TE 10i	19,917	1,950	930	3,435	174	1,030	935	950	3,199	1,130	950	960	1,050	214	1,260
TE 10.5i	22,034	2,028	990	3,623	183	1,060	995	1,110	3,387	1,180	1,000	1,005	1,100	221	1,440
TE 11i	24,169	2,126	1,025	3,812	188	1,130	1,030	1,230	3,575	1,230	1,050	1,050	1,150	228	1,620
TE 12i	28,820	2,303	1,105	4,192	202	1,210	1,110	1,520	3,954	1,310	1,130	1,130	1,230	242	1,970
TE 13i	33,771	2,477	1,175	4,566	216	1,280	1,180	1,830	4,335	1,380	1,200	1,200	1,300	262	2,410
TE 14i	38,782	2,654	1,255	4,947	225	1,360	1,260	2,140	4,708	1,460	1,280	1,280	1,380	271	2,810
TE 15i	44,098	2,831	1,340	5,329	238	1,440	1,345	2,570	5,090	1,540	1,360	1,370	1,460	285	3,340
TE 16i	49,671	3,757	1,450	7,266	250	1,550	1,455	3,180	7,028	1,670	1,470	1,480	1,570	302	4,180
TE 17i	55,665	3,978	1,525	7,741	266	1,630	1,530	3,730	7,504	1,750	1,550	1,550	1,650	318	4,780
TE 18i	62,000	4,199	1,600	8,218	280	1,700	1,605	4,300	7,979	1,890	1,620	1,630	1,720	335	5,620
TE 19i	68,577	4,416	1,680	8,687	294	1,780	1,685	4,980	8,676	1,970	1,700	1,710	1,800	349	6,420
TE 20i	75,590	4,637	1,755	9,164	302	1,860	1,760	5,540	8,925	2,050	1,780	1,780	1,880	357	7,120

*) Bu, Bo: Widths of anchor plates, below and above; Lu, Lo: Lengths of anchor plates, below and above

***) Including anchor plates

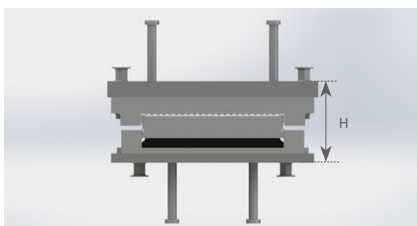

Section through TE bearing with dowels (without anchor plates)

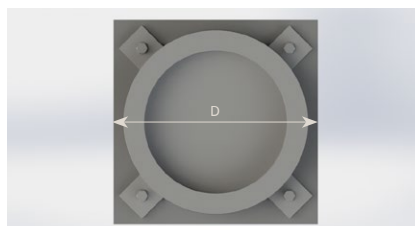

Plan view of pot of a TE bearing

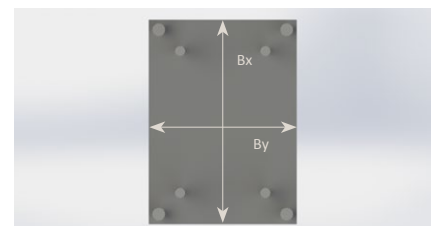

Plan view of sliding plate of a TE bearing



Typical dimensions – Type TA

RESTON®POT bearings of type TA facilitate movements in every direction and rotations about every axis. This type of bearing cannot transmit any horizontal forces except friction. The bearing is connected to the superstructure and substructure by means of threaded sleeves or anchor plates with shear studs.

Bearing dimensions and weights for deviating requirements can be determined on request.

Dimensions for concrete class C30/37 (based on EN 1337)

Type	N _{rd} [kN]	D [mm]	Without anchor plates				With anchor plates					
			H [mm]	B _x [mm]	B _y [mm]	Weight [kg]	H*	Anchor plates**				Weight [kg]
								B _u [mm]	L _u [mm]	B _o [mm]	L _o [mm]	
TA 1	714	200	86	300	260	30	120	270	270	270	320	55
TA 1.5	1,193	240	85	380	300	45	120	295	295	300	355	68
TA 2	1,595	270	86	370	320	50	120	320	320	330	390	80
TA 2.5	2,231	310	86	440	350	65	124	350	350	370	430	105
TA 3	2,913	350	95	450	390	85	128	380	380	410	470	130
TA 3.5	3,577	390	95	510	430	105	133	415	415	445	505	160
TA 4	4,496	420	105	520	460	130	138	450	450	480	540	190
TA 4.5	5,267	460	105	580	500	155	147	485	485	520	580	240
TA 5	6,388	500	119	600	540	200	155	520	520	560	620	290
TA 5.5	7,315	540	119	640	580	225	158	560	560	595	655	335
TA 6	8,647	570	123	670	610	260	161	600	600	630	690	380
TA 6.5	9,661	625	129	730	650	325	168	635	635	670	730	448
TA 7	11,207	650	136	750	690	365	175	670	670	710	770	515
TA 7.5	12,375	690	142	790	730	425	180	705	705	745	805	583
TA 8	14,143	720	146	820	760	470	184	740	740	780	840	650
TA 8.5	15,425	760	150	860	800	530	192	780	780	820	880	753
TA 9	17,422	800	161	900	840	630	199	820	820	860	920	855
TA 9.5	18,758	840	164	940	880	700	207	860	860	900	960	980
TA 10	20,986	880	174	980	920	820	215	900	900	940	1,000	1,105
TA 10.5	22,933	930	175	1,030	970	905	219	940	940	980	1,040	1,230
TA 11	24,942	960	183	1,060	1,000	1,010	223	980	980	1,020	1,080	1,355
TA 12	29,239	1,040	192	1,140	1,080	1,235	233	1,060	1,060	1,100	1,160	1,645
TA 13	33,807	1,130	211	1,230	1,170	1,595	257	1,150	1,150	1,190	1,250	2,130
TA 14	38,782	1,210	226	1,310	1,250	1,950	272	1,230	1,230	1,270	1,330	2,560
TA 15	44,098	1,300	235	1,400	1,340	2,325	281	1,320	1,320	1,360	1,420	3,025
TA 16	49,671	1,380	249	1,480	1,420	2,775	300	1,400	1,400	1,440	1,500	3,650
TA 17	55,665	1,460	262	1,560	1,500	3,270	314	1,480	1,480	1,520	1,580	4,260
TA 18	62,000	1,540	271	1,640	1,580	3,730	326	1,560	1,560	1,600	1,660	4,885
TA 19	68,577	1,620	281	1,720	1,660	4,245	336	1,640	1,640	1,680	1,740	5,520
TA 20	75,590	1,710	300	1,810	1,750	5,105	355	1,730	1,730	1,770	1,830	6,520

*) Including anchor plates

**) B_o, B_u: Widths of anchor plates, above and below; L_o, L_u: Lengths of anchor plates, above and below

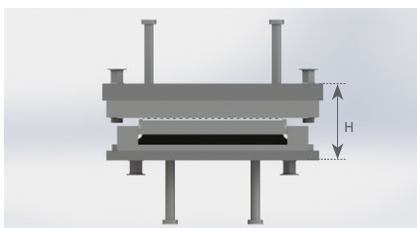

Section through TA bearing with threaded sleeve anchors (without anchor plates)

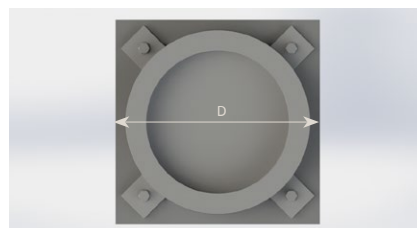

Plan view of pot of a TA bearing

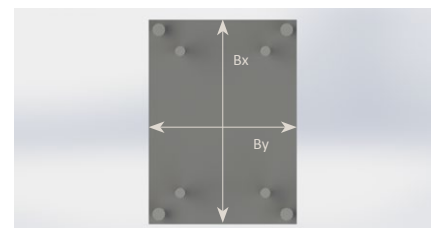

Plan view of sliding plate of a TA bearing