



Expansion joints

mageba flexible plug expansion joint – the new generation



TENSA® POLYFLEX® Advanced PU

maximum driving comfort, wear-resistant, watertight



mageba



Product Characteristics

Principle

The TENSA®POLYFLEX®Advanced PU Flexible Plug Expansion Joint System achieves a completely new standard in terms of quality and service life.

Compared to other expansion joint designs, flexible plug expansion joints offer several advantages including: unsurpassed driver comfort, no added noise emission, watertight, installable in sections (e.g. lane-by-lane), etc.

Traditional bituminous based expansion joint materials have several disadvantages. Softer materials with lower reaction forces are not sufficiently stable and deform plastically at high temperatures and traffic loads (especially when vehicles are braking). By contrast, harder material has higher reaction forces – causing surface debonding at lower temperatures which leads to leakages.

Varying quality due to proper mixture and temperature during installation (at appr. 180 °C/356 °F) and limitation to small movements also frequently cause problems. The elasto-plastic behavior of bituminous mixtures causes permanent loads (e.g. ballast gravel) to sink into the material. For this reason, conventional bituminous plug joints are not suitable for railway bridges with ballast beds, whereas TENSA®POLYFLEX® joints are.

mageba's flexible PU material (developed in cooperation with leading chemical industries) and special joint design have solved the above mentioned problems.

Additionally, it is a unique solution for the design of integral bridges as a crack-free link between bridge and abutment.

Characteristics

The TENSA®POLYFLEX®Advanced PU joint uses a durable fully elastic material with an enormous tear resistance and low reaction forces. Perforated steel angles within the PU-material help to accommodate horizontal braking and reaction forces and allow for a clean bond between surfaces free of leakages from ingressing water.

The new material has an exceptionally long lifespan and is resistant to wear and environmental and chemical influences. Its working life is substantially higher than that of most roadway surface materials.

The material has shown test values of 650 % elongation before breaking, which makes the material a perfect choice for use in expansion joint systems.

PU material can be cast for nearly any joint shape (e.g. upstands, skew, T and X joints, etc.). The two-component material is mixed in complete packing units at ambient temperature, thus avoiding the possibility of on-site mixing failures. Processing is possible at temperatures between 5 °C and 35 °C (41 °F and 95 °F), virtually independent of humidity. The joint can be driven over after a few hours. Full functionality of the joint is given in a temperature range between -50 °C and 70 °C (-58 °F and 158 °F), which is a major improvement over bituminous plug joints.

The flexible plug expansion joint system, TENSA®POLYFLEX®Advanced PU, is a complete new development based on elastic polymers and a further development of the traditional asphaltic plug joint, whereby disadvantages of the traditional bituminous plug joint (e.g. debonding,

plastic deformation, rutting, overload due to standing traffic, etc.) can be eliminated.

An essential advantage of the TENSA®POLYFLEX® expansion joint system is the individual adaptation of each joint to the unique requirements of each bridge. Thicknesses and widths of these joints are set to the most efficient and economical dimensions possible, without the limitations of standard requirements.

Total movements of up to 100 mm (4 in) have been accommodated in several countries on various projects in successful operation since 2007.

With state of the art manufacturing technology, a highly qualified staff, and a quality management according to EN ISO 9001:2008, mageba has the capabilities and experience to accomplish these projects.

Highlights – Scope of Application

- Bridge structures for all traffic types (road, pedestrian and railway bridges)
- Architectural and industrial structures
- Railway stations
- Parking decks
- Airport buildings, hangars and runways
- Sterile joints for pharmaceutical industries
- Chemical industries, where resistance to alkaline and acids is required
- Clinics, hospitals and laboratories
- Food processing industries
- Replacement of traditional steel joints
- Sliding floors in heavy load industries

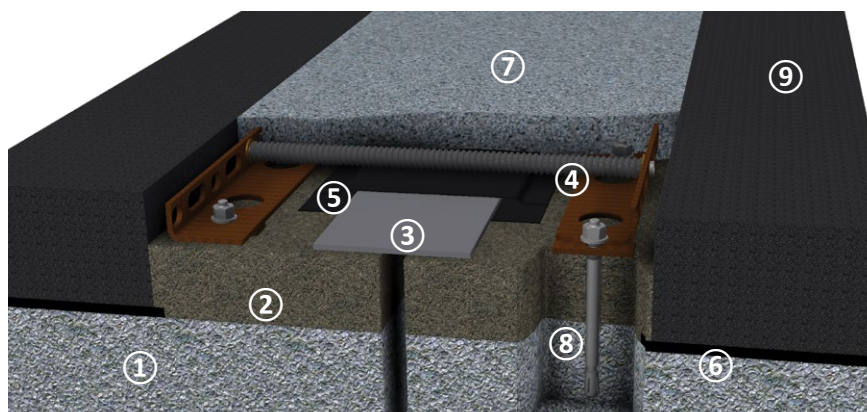

- 1 Abutment
- 2 Polymer concrete bedding
- 3 Cover plate
- 4 Perforated steel angle
- 5 EPDM sliding sheet
- 6 Bridge sealing
- 7 TENSA®POLYFLEX®Advanced PU-flexible material
- 8 Anchoring
- 9 Surfacing made of asphalt or concrete

Client Benefits

Advantages & Properties

- Exceptional long service life, longer than adjacent surfaces
- Highest possible driver comfort
- No noise from crossing traffic due to surface that is flush with adjacent road
- Watertight
- Maintenance-free; cleaning not required
- Suitable for new structures and refurbishments
- Quickly installed lane-by-lane with minimal impact on traffic, drivable after a few hours (overnight installation)
- Installation within a wide temperature range (5 °C to 35 °C/41 °F to 95 °F)
- Wear-resistant; no mechanical wear parts
- No rutting, high resistance to abrasion (e.g. braking traffic, mountain areas, etc.)
- Damages in the joint can be easily repaired by reactivation of the PU material (e.g. scratches from snowplows etc.),
- No recess for anchorage in structural concrete necessary
- Surfacing (asphalt or concrete) can be applied continuously before joint installation
- Any horizontal bend in the direction of joint possible
- Any curb/sidewalk detail possible
- No noise emission due to tire impact with adjacent structural parts
- Not susceptible to vibrations
- Low reaction forces
- Cold processing and easy material handling with preset mixing ratio, thus no mixing defects
- Resistant to environmental influences and chemicals
- Resistant to alkaline, acids, chlorides, etc.
- Free of germs and fungus
- Color available in gray and black
- Smooth surface ideal for walking areas of airports or railway stations

Damage Repair & Partial Installations

Traffic accidents or road maintenance vehicles such as snowplows can cause damage to traditional expansion joints leading to high repair costs.

Local damages to the TENSA®POLYFLEX®Advanced PU joint material are repaired easily by cutting out the affected areas from the surface followed by chemical reactivating the cured PU material.

Then, the damaged areas can be filled up with new PU material and the surface coating, if any, can be applied to the refurbished areas.

A similar procedure of chemically reactivating cured material is done at partial installations, e.g. if a lane-by-lane installation is necessary.

Examples

Standard Road ①

TENSA®POLYFLEX®Advanced PU joint for road bridges with continuously applied surfacing before joint installation. Useable for new bridges with high loads and large movements, as integral bridge joint filler or for refurbishment.

Standard Light Load ②

This TENSA®POLYFLEX®Slim PU joint design with reduced width and small perforated steel angles is used for light loads (e.g. park decks, airport or railway station joints, commercial buildings, warehouses, high-bay warehouses, industrial plants).

Intersections ③

Intersection of TENSA®POLYFLEX®Advanced PU joints, such as T-crossing or X-crossing in any shape or angle, is possible. For such cases, please contact mageba experts.

Vertical Joints ④

TENSA®POLYFLEX®Advanced PU material also allows the design of vertical joints with no limit to inclination or width. Butt joints to horizontal joints can be easily casted in any shape.

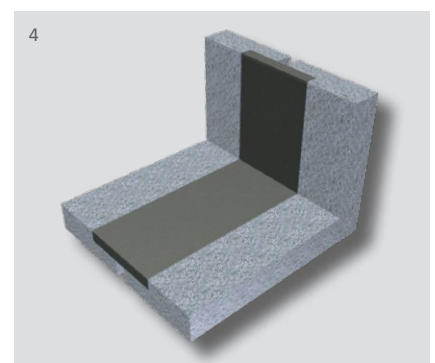
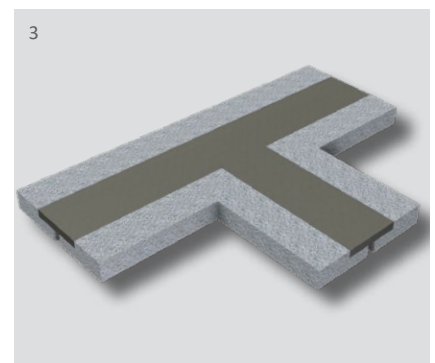
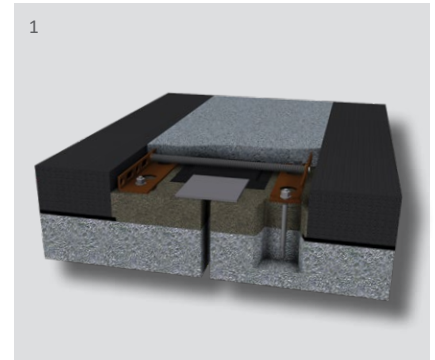



Expansion joints

Design Details & Movement Capacity

Design Principles

The TENSA®POLYFLEX® Advanced PU filling material shows excellent adhesion to the supporting structure as well as to the adjacent surfacing, and is therefore capable of safely transferring horizontal loads to the structure.

Additionally, perforated steel angles, which are fully embedded within the joint material, are bolted to the structure and can transfer even the highest loads (e.g. from heavy vehicles braking on the joint at downward slopes).

These steel angles also support the adjacent surfacing so as to prevent the asphalt from being depressed into the sides of the joint material.

It is strongly recommended to use additional transition strips and/or support ribs to secure the strength of adjacent bituminous surfacing areas.

A cover plate bridges the structural gap and is designed to withstand all traffic loads while stabilizing elements within the joint material restrain vertical displacements to limited values. These values are derived from the "ETAG 032 – Guideline for European Technical Approvals of Expansion Joints for Road Bridges" and ensure traffic safety as well as for a perfect driver comfort.

The waterproofing membrane of the structure is integrated into the joint filling material or the polymer concrete bedding material for the substructure to make the whole system watertight.

Dimensions

The tables below show examples of joint dimensions for a preliminary design stage. For final design, the width and height of the joint are individually determined according to the actual movements. All joint types can accommodate vertical movements of ± 10 mm for replacement of bridge bearings.

System Types PA 15 – PA 50 (without stabilizing elements)

	PA 15 [mm]		PA 20 [mm]		PA 30 [mm]		PA 40 [mm]		PA 50 [mm]		
total movement e	15		20		30		40		50		
movement tension e'	10		13		20		26		33		
movement compression e-	5		7		10		14		17		
thickness D	60		60		60		60		60		
joint width in middle position B ₀	290	330	290	330	330	360	360	390	430	430	460
gap at middle position S ₀	10-36	10-60	12-27	12-67	15-47	15-60	19-36	19-54	22-47	22-77	22-100
bridging element width b _B	80	120	80	120	120	150	120	150	150	180	220
sliding sheet width b _F	80	120	80	120	120	150	150	180	220	220	250
steel angle	70 x 45 x 6										

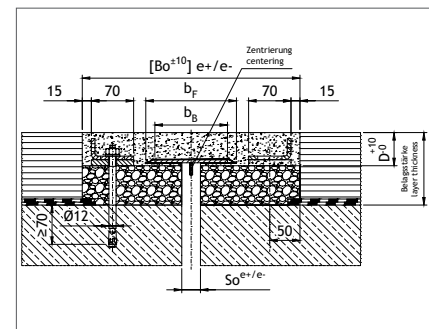

System Types PA 60 – PA 135 (with stabilizing elements)

	PA 60 [mm]		PA 75 [mm]		PA 80 [mm]		PA 90 [mm]		PA 100 [mm]		PA 110 [mm]		PA 120 [mm]		PA 130 [mm]		PA 135 [mm]		
total movement e	60		75		80		90		100		110		120		130		135		
movement tension e'	40		50		53		60		66		74		80		86		90		
movement compression e-	20		25		27		30		34		36		40		44		45		
thickness D	70																		
joint width in middle position B ₀	500	500	520	580	580	650		730		800		880		950		1030		1100	
gap at middle position S ₀	22-36	25-63	25-100	30-41	30-80	32-70		35-56		39-69		41-48		45-52		49-54		50	
bridging element width b _B	150	180	220	180	220	220		220		250		250		270		290		290	
sliding sheet width b _F	250	250	270	330	330	400		480		550		630		700		780		850	
steel angle	90 x 55 x 6																		
stabilizing element distance eS	200									150									

Note: Achievable movements in Serviceability Limit State (SLS) observing maximum permissible vertical deflections. at Ultimate Limit State (ULS) significantly larger movements can be accommodated. Please contact mageba experts for further details. For refurbishments, the actual width of the structural gap shall be considered for detail design of joint.

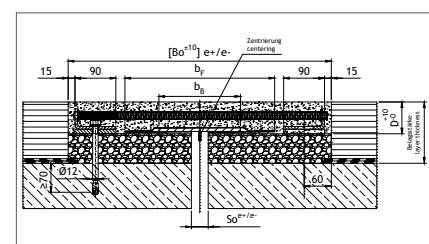

Testing and Verification

Wheel tracking comparison test

A wheel tracking test according to EN 12697-22 was performed by the Testing Institute MAPAG in August of 2009. Testing was done on two different plug joint systems with the following results:

Estimation of working life:	
Conventional asphaltic plug expansion joint (picture ①)	0
BT 16 HS LKS (common asphaltic surfacing)	1
TENSA®POLYFLEX®Advanced PU expansion joint (picture ②)	≥ 2

In practice, this means that the expected service life for TENSA®POLYFLEX® Advanced PU flexible plug expansion joints will be more than 2 times higher than the service life of the adjacent road surfacing.

Mechanical Resistance and Resistance to Fatigue

At the testing facility of Technical University of Munich, Germany (Prüfamt für Verkehrswegebau, TU München) tests of mechanical resistance and resistance to fatigue according to ETAG 032-3, Annex 3-M were carried out on two test specimens of a PA 75 TENSA®POLYFLEX®Advanced PU expansion joint.

These tests included:

- test method a) “resistance to vertical static load and recovery after unloading” and
- test method b) “resistance to repeated vertical dynamic load”

Test method a) was carried out at an ambient temperature of 23 °C ±2 °C (73.4 °F ±3.6 °F) using a mean contact pressure of 0.94 MPa applied with a vertical force of 150 kN through a load distribution pad of 400 x 400 mm simulating the wheel print defined in ETAG 032-1, Annex G. The specimen further showed an opening position of 100 % of the declared value for the tested type PA75.

After applying the load for 5 minutes, elastic deformations and recovery during the following hour were recorded. The recordings showed a highest value for elastic deformation of 0.5 mm directly after unloading and a full recovery after one hour.

The test was then carried out again after cutting the load distribution pad in two halves resulting in a halved wheel print of 400 x 200 mm and a doubled mean contact pressure of 1.87 MPa. Even under these extreme testing conditions, the highest elastic deformation was only 1.4 mm and the remaining deformation after one hour was only 0.5 mm directly under the load distribution pad.

Test method b) was a “classic” roll-over test carried out at an inner specimen temperature of 45 °C (113 °F) using standard twin tires 7.50R15. The tires were vertically loaded with 45 kN and inflated with a pressure of 10 bar (145 psi) resulting in a contact pressure of approximately 1.0 MPa – more than twice the required value of 0.46 MPa as per ETAG 032-3. The roll-over speed was chosen as 0.2 m/s and a lateral shifting of wheel tracks in a range of ±2 cm was simulated. The specimen was showing an opening position of 60 % of the declared value for the tested type. Next, 3,000 roll-over cycles were carried out followed by another 30 cycles with a simulated braking force of 10 % of the vertical load. The number of load cycles was 50% higher than the 2,000 cycles required according to ETAG 032-3.

The surface profile was recorded after every 500 cycles to show possible effects of wheel tracking, but the elastic deformations were negligibly small and no remaining wheel tracking was recorded!



- 1 Traditional bituminous plug joint after 100 load cycles at 60 °C (140 °F)
- 2 TENSA®POLYFLEX expansion joint after 30,000 load cycles at 60 °C (140 °F)
- 3 Resistance to vertical static load and recovery after unloading
- 4 Resistance to repeated vertical dynamic load



Testing and Verification

Movement Capacity Test & Material Characteristics test

At the Federal Institute for Materials Research and Testing (BAM) in Berlin, Germany, movement capacity tests according to ETAG 032-3, Annex 3-N have been carried out on a test sample of a PA 50 Tensa®POLYFLEX®Advanced PU expansion joint.

During test method a) "Movement capacity under slow occurring movements", the temperature of the specimen was controlled according to the applied movements. Therefore, the maximum tension of 33 mm was applied at -40 °C (-40 °F) and the maximum compression of 17 mm at 60 °C (140 °F).

Reaction forces resulting from the applied movements were recorded as well as the surface profiles at extreme positions. At maximum tension and a temperature of -40 °C (-40 °F), the system showed reaction forces of approximately 50 kN per running meter of joint while the maximum vertical displacement under maximum compression at 60 °C (140 °F) was only 6 mm.

Test method b) "Movement capacity under fast occurring movements" was run with 7.5 million load cycles at 15 °C (59 °F) and an additional 180,000 cycles at -40 °C (-40 °F). A dynamic amplitude of +1 mm and a frequency of 5 Hz was chosen for this test.

Further tests have been successfully completed including artificial weathering, artificial aging, spectroscopy analysis, thermal analysis, hardness testing, tensile testing, dynamic-mechanical analysis, and bonding tests.

All determined test results are far better than comparable values of traditional bituminous plug expansion joints. This again emphasizes the extraordinary capabilities of the new Tensa®POLYFLEX®Advanced PU expansion joint system.

Since July 2012, mageba received the European Technical Approval ETA 12/0260 for the product system Tensa®POLYFLEX®Advanced PU. An update took place in April 2019.

This European technical approval has been issued in accordance with Regulation (EU) No 305/2011 on the basis of:

- EAD 120011 01 0107; „Flexible Plug Expansion joints for road bridges with flexible filling based on synthetic polymer as binder“
- ETAG 032-1; „Guideline for European technical approval of Expansion joints for road bridges“, edition of May 2013

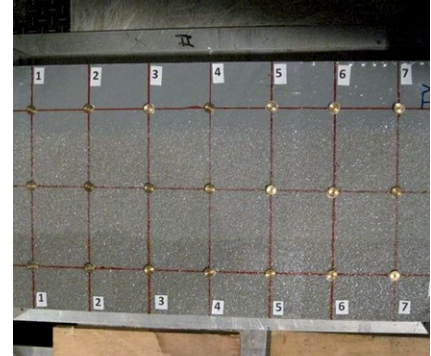

Movement capacity tests Tensa®POLYFLEX® Advanced PU

Materials & Installation

Material Description

TENSA®POLYFLEX®Advanced PU is an elastic, solvent-free 2-component grout system developed for the application of flexible plug expansion joint systems.

The polymer concrete recommended for the support is a cold processed grout system adapted to the TENSA®POLYFLEX®Advanced PU joint in terms of workability and endurance.



Technical data of PU material*)

density	g/cm ³	1,05
hardness shore A according to DIN 53505	Shore A	approx. 65
tensile strength according to DIN 53504	N/mm ²	14
elongation at break according to DIN 53504	%	650
tear strength according to DIN 53515	N/mm ²	20
processing time („pot life“)		
at 10 °C	min.	40
at 20 °C	min.	30
at 30 °C	min.	20
trafficability		
at 10 °C	h	approx. 24
at 20 °C	h	approx. 12
full cure		
at 10 °C	d	5
at 20 °C	d	4
recommended substrate temperatures		
	°C	min. 5
	°C	max. 35
recommended relative humidity		
	%	max. 80

*) indications only.



- 1 Marking and cutting of the continuously applied surfacing
- 2 Removal of asphalt and cutting of support ribs

- 3 Cleaning, sandblasting and application of primer
- 4 Creating polymer-concrete base

- 5 Installation of steel angles and coverplate
- 6 Filling with TENSA®POLYFLEX®Advanced PU material
- 7 Finished expansion joint



Expansion joints

Quality & Support

Installation

For new structures, the bituminous surfacing shall be made in advance. For concrete surfacing and at edge beams, adequate recesses shall be provided.

If the joint is installed upon a concrete support, the minimal nominal compressive strength must be 25 N/mm².

To ensure watertightness of the whole system, the waterproofing membrane shall be applied up to the bridge gap. During installation of the TENSA®POLYFLEX®Advanced PU joint, the waterproofing is cut and integrated into the PU material or the polymer concrete substructure.

Digital installation supervision

In keeping with the company's spirit of innovation, mageba introduced remote supervision of installation work in 2021. The use of the latest communication technology can make the presence of an installation specialist on site unnecessary in most cases. With the help of a head-mounted mini-tablet with video functionalities worn by a colleague on site, transmitting real-time video images, a mageba engineer or installation specialist at another location can efficiently oversee and coordinate the installation work. A new era in terms of cost reduction, flexibility and environmental sustainability.

Consulting

mageba offers full technical support to help determine the proper joint width and details with consideration of all technical and economic aspects in order to calculate the optimum and most cost-effective solution.

TENSA®POLYFLEX®Advanced PU flexible plug expansion joints can be installed either by mageba personnel or by customer personnel, so long as they are specially trained and certified by mageba. Supervision of installation works can also be provided by mageba experts upon request.

A valid ISO 9001 certification, 100 % factory production control and continuous third party quality control by a German governmental body, the Material Testing Institute of the University in Stuttgart (MPA) ensure both the high quality level of products and manufacturing facilities.

mageba product specialists are pleased to provide advice in the selection of the optimal solution for any project and to provide pricing.

Please visit mageba-group.com for further product information, including reference lists and tender documentation.

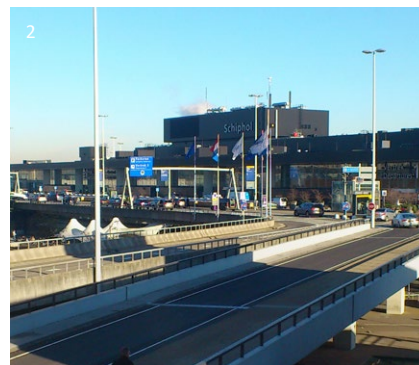
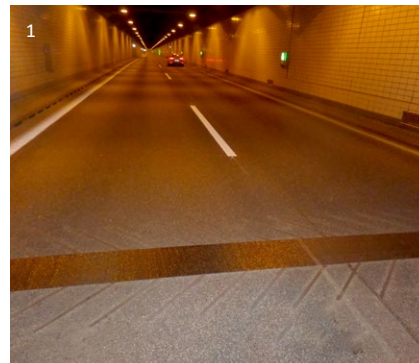

- 1 A7 Elbtunnel-Hamburg, Equipped with TENSA®POLYFLEX®Advanced PU expansion joints type PA 40
- 2 Airport Schiphol, Netherlands Equipped with TENSA®POLYFLEX®Advanced PU expansion joints type PA 30

Reference projects – TENSA®POLYFLEX®Advanced PU



Edingen A 45 (DE)



Dreyerstraße-Hannover (DE) Riefensberger Brücke (AT)



Longdong Avenue (CN)



Kabutotori Bridge (JP)



Avrasya Tunnel (TR)

mageba expansion joint types



Single gap joints



Cantilever finger joints



Sliding finger joints



Modular expansion joints

mageba
mageba-group.com

engineering connections®