



# RESTON® SPHERICAL Bearings

## Introduction

The following tables indicate the dimensions of RESTON® SPHERICAL bearings with ROBO® SLIDE 75 sliding material, for a selection of vertical loads up to 50 MN. Minimum movements, supplemental movements and minimum dimensions in accordance with the European standard EN 1337 are considered. It should be noted that the height of a bearing can be up to 10 mm more than indicated, due to fabrication tolerances.

In determining bearing dimensions, the following assumptions were made.

## Load Combinations

Bearings are dimensioned to resist the maximum vertical and horizontal forces indicated in the tables.

Horizontal forces are assumed to be 10% of the vertical loads. Maximum permissible horizontal loads are assumed to act only in combination with a simultaneously acting vertical load of approximately 30% of the maximum vertical load (with friction thus resisting some of the horizontal force). More demanding load combinations must be checked individually.

The relevant parameters are:

- $N_{Rd}$ : Maximum vertical load capacity of the bearing (ULS)
- $V_{Rd}$ : Maximum horizontal load capacity of the bearing (ULS), under a vertical load of 30% of  $N_{Rd}$
- $N_{d,min}$ : Minimum required vertical load with a simultaneous horizontal load,  $V_{Rd}$  (ULS)

It is assumed that friction can be considered to resist some of the horizontal forces (with the exception of railway bridges and seismic loading).

The load combinations are in accordance with EN 1991. If the design loads are not in accordance with this standard, detailed design will be in accordance with the applicable norm (e.g. AASTHO, BS, SIA, etc.).

## Concrete Strength

The pressure acting on concrete main structures is calculated in accordance with EN 1992 (partial surface pressure). Due to the high strength of ROBO® SLIDE 75 sliding material, RESTON® SPHERICAL bearings are preferably used in combination with high-strength concrete.

## Movements

- KE bearings: Total longitudinal movement of 100 mm (+/- 50 mm)
- KA bearings: Total longitudinal movement of 100 mm (+/- 50 mm), and transverse movement of 40 mm (+/- 20 mm)

Bearings can also be designed for larger longitudinal and transverse movements. This requires the dimensions of the sliding plate, the height and the upper anchorage to be adapted. For longitudinally fixed KE bearings, the movement is normally reduced.

## Support

Our product specialists are always ready to advise you in selecting the optimal solution for your project, and to provide you with quotations for supply.

You can also find further information at [mageba-group.com](http://mageba-group.com) and in the relevant product brochure.

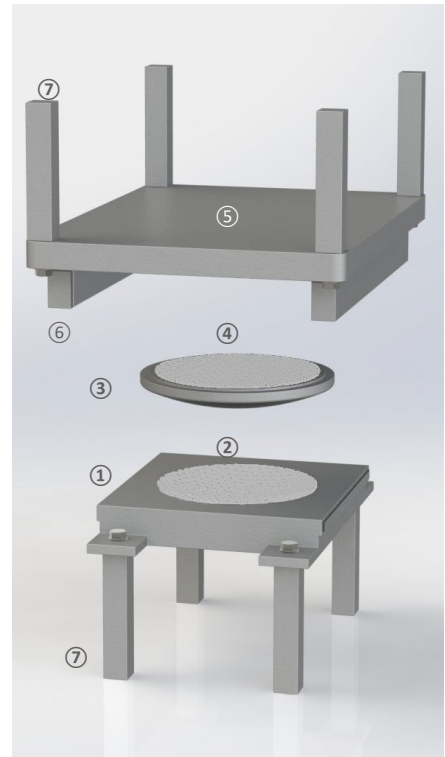

- 1 Concave lower part
- 2 ROBO® SLIDE 75 sliding material
- 3 Calotte
- 4 ROBO® SLIDE 75 sliding material
- 5 Sliding plate (for KE and KA bearings)
- 6 Guide bars (for KE bearings)
- 7 Dowels or threaded sleeves (also possible: anchor plates with shear studs)





# Typical Dimensions – Type KF

RESTON®SPHERICAL Bearings of Type KF resist horizontal forces in every direction and facilitate rotations about every axis. The bearing is connected to the superstructure and substructure by means of dowels or of anchor plates with shear studs.

Bearing dimensions and weights for deviating requirements can be determined on request.

## Dimensions for concrete class C30/37 (based on EN 1337)

Type	N <sub>Rd</sub> [kN]	N <sub>d,min</sub> [kN]	V <sub>Rd</sub> [kN]	Without anchor plates				With anchor plates					
				D [mm]	B [mm]	H [mm]	Weight [kg]	Anchor plates*				H** [mm]	Weight [kg]
								Bu [mm]	Lu [mm]	Bo [mm]	Lo [mm]		
KF 1.0	1,000	300	100	182	228	76	32	316	316	316	316	141	69
KF 2.0	2,000	600	200	236	292	80	48	330	330	350	350	137	90
KF 3.0	3,000	900	300	289	340	89	66	370	370	380	380	147	120
KF 4.0	4,000	1,200	400	332	375	90	80	390	390	410	410	143	139
KF 5.0	5,000	1,500	500	364	415	98	100	405	405	425	425	151	161
KF 6.0	6,000	1,800	600	396	441	102	117	446	430	455	455	151	185
KF 7.0	7,000	2,100	700	434	487	105	145	476	460	495	495	148	215
KF 8.0	8,000	2,400	800	461	523	104	163	509	485	535	535	138	232
KF 9.0	9,000	2,700	900	496	581	99	186	519	500	550	550	137	245
KF 10.0	10,000	3,000	1,000	514	570	108	200	580	526	585	585	138	278
KF 12.0	12,000	3,600	1,200	556	602	125	257	586	562	600	600	146	314
KF 15.0	15,000	4,500	1,500	620	671	147	375	684	637	690	690	160	454
KF 20.0	20,000	6,000	2,000	715	761	165	538	748	732	790	790	168	624
KF 25.0	25,000	7,500	2,500	802	884	172	750	848	810	900	900	189	881
KF 30.0	30,000	9,000	3,000	880	1,027	167	944	912	897	1,010	1,010	191	1,140
KF 40.0	40,000	12,000	4,000	1,031	1,237	168	1,389	1,054	1,029	1,195	1,195	215	1,776
KF 50.0	50,000	15,000	5,000	1,155	1,403	181	1,920	1,193	1,155	1,402	1,402	241	2,657

\* Bu, Bo: Widths of anchor plates, below and above; Lu, Lo: Lengths of anchor plates, below and above

\*\* Including anchor plates

## Dimensions for concrete class C50/60 (based on EN 1337)

Type	N <sub>Rd</sub> [kN]	N <sub>d,min</sub> [kN]	V <sub>Rd</sub> [kN]	Without anchor plates				With anchor plates					
				D [mm]	B [mm]	H [mm]	Weight [kg]	Anchor plates*				H** [mm]	Weight [kg]
								Bu [mm]	Lu [mm]	Bo [mm]	Lo [mm]		
KF 1.0	1,000	300	100	182	228	76	32	316	316	316	316	131	66
KF 2.0	2,000	600	200	236	292	80	48	325	325	340	340	139	86
KF 3.0	3,000	900	300	274	340	89	65	355	355	375	375	148	112
KF 4.0	4,000	1,200	400	307	375	85	74	390	390	405	405	143	136
KF 5.0	5,000	1,500	500	339	413	89	90	410	410	430	430	151	161
KF 6.0	6,000	1,800	600	366	446	89	103	435	435	455	455	151	182
KF 7.0	7,000	2,100	700	382	472	96	122	450	450	485	485	150	204
KF 8.0	8,000	2,400	800	409	503	95	135	475	475	520	520	149	230
KF 9.0	9,000	2,700	900	447	541	89	144	500	500	550	550	144	251
KF 10.0	10,000	3,000	1,000	469	563	95	166	515	515	580	580	142	273
KF 12.0	12,000	3,600	1,200	491	593	94	184	550	550	620	620	147	324
KF 15.0	15,000	4,500	1,500	454	667	96	233	580	580	670	670	164	405
KF 20.0	20,000	6,000	2,000	615	771	99	320	650	650	770	770	152	527
KF 25.0	25,000	7,500	2,500	680	868	117	468	705	705	845	845	188	710
KF 30.0	30,000	9,000	3,000	756	972	120	599	780	780	950	950	184	894
KF 40.0	40,000	12,000	4,000	896	1,184	136	1,012	905	905	1,125	1,125	207	1,417
KF 50.0	50,000	15,000	5,000	1,032	1,366	153	1,500	1,025	1,025	1,305	1,305	219	2,036

\* Bu, Bo: Widths of anchor plates, below and above; Lu, Lo: Lengths of anchor plates, below and above

\*\* Including anchor plates

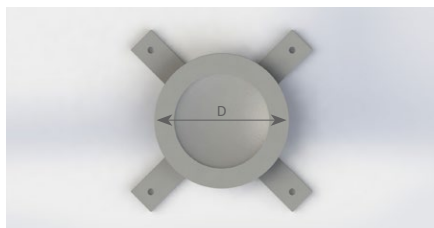

Top view of lower part of a KF bearing

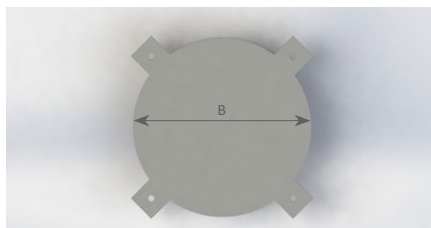

Top view of the upper part of a KF bearing

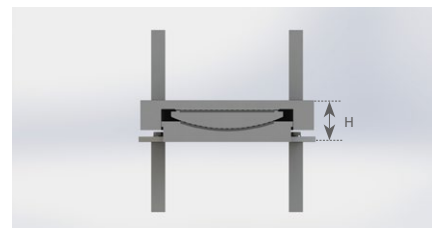

Section through KF bearing without anchor plates, with dowels



# Typical Dimensions – Type KE

RESTON®SPHERICAL Bearings of Type KE can move along one horizontal axis and resist horizontal forces transverse to that axis, while accommodating rotations about every axis. The bearing is connected to the superstructure and substructure by means of dowels or of anchor plates with shear studs. Bearing dimensions and weights for deviating requirements can be determined on request.

## Dimensions for concrete class C30/37 (based on EN 1337)

Type	N <sub>Rd</sub>	N <sub>d,min</sub>	V <sub>Rd</sub>	Without anchor plates						With anchor plates					
				Ax	Ay	Bx	By	H	Weight	Anchor plates*				H**	Weight
										Bu	Lu	Bo	Lo		
[kN]	[kN]	[kN]	[mm]	[mm]	[mm]	[mm]	[mm]	[mm]	[kg]	[mm]	[mm]	[mm]	[mm]	[mm]	[kg]
KE 1.0	1,000	300	100	224	200	310	320	95	53	410	316	405	330	150	85
KE 2.0	2,000	600	200	231	231	330	351	110	76	405	316	450	365	168	113
KE 3.0	3,000	900	300	286	286	390	406	117	112	470	316	515	405	170	158
KE 4.0	4,000	1,200	400	333	333	445	453	117	141	490	329	540	430	192	200
KE 5.0	5,000	1,500	500	369	369	495	489	127	184	530	364	575	455	195	239
KE 6.0	6,000	1,800	600	402	402	530	522	132	217	545	391	595	475	205	271
KE 7.0	7,000	2,100	700	440	470	565	590	127	257	590	438	645	500	201	328
KE 8.0	8,000	2,400	800	463	463	600	583	148	313	595	500	645	620	181	370
KE 9.0	9,000	2,700	900	490	505	630	625	143	345	635	520	680	640	181	410
KE 10.0	10,000	3,000	1,000	515	520	655	640	148	379	660	540	710	660	181	445
KE 12.0	12,000	3,600	1,200	561	600	705	720	153	475	730	575	780	695	192	536
KE 15.0	15,000	4,500	1,500	622	622	790	742	179	644	770	629	825	745	205	700
KE 20.0	20,000	6,000	2,000	716	716	890	836	203	944	845	728	905	805	237	1,009
KE 25.0	25,000	7,500	2,500	814	814	1,000	934	206	1,221	895	803	960	850	269	1,312
KE 30.0	30,000	9,000	3,000	869	869	1,075	989	248	1,675	950	878	1,025	905	292	1,657
KE 40.0	40,000	12,000	4,000	1,010	1,010	1,235	1,130	258	2,348	1,080	1,035	1,150	1,155	296	2,444
KE 50.0	50,000	15,000	5,000	1,128	1,155	1,370	1,275	289	3,348	1,235	1,152	1,310	1,265	327	3,461

\* Bu, Bo: Widths of anchor plates, below and above; Lu, Lo: Lengths of anchor plates, below and above

\*\* Including anchor plates

## Dimensions for concrete class C50/60 (based on EN 1337)

Type	N <sub>Rd</sub>	N <sub>d,min</sub>	V <sub>Rd</sub>	Without anchor plates						With anchor plates					
				Ax	Ay	Bx	By	H	Weight	Anchor plates*				H**	Weight
										Bu	Lu	Bo	Lo		
[kN]	[kN]	[kN]	[mm]	[mm]	[mm]	[mm]	[mm]	[mm]	[kg]	[mm]	[mm]	[mm]	[mm]	[mm]	[kg]
KE 1.0	1,000	300	100	177	170	265	310	107	52	410	316	405	330	150	85
KE 2.0	2,000	600	200	221	200	320	350	110	71	405	316	450	365	168	113
KE 3.0	3,000	900	300	248	230	360	380	123	97	470	316	510	405	161	147
KE 4.0	4,000	1,200	400	277	255	400	410	128	124	490	316	540	430	183	188
KE 5.0	5,000	1,500	500	324	325	450	445	128	155	530	322	575	455	183	217
KE 6.0	6,000	1,800	600	329	310	470	455	138	181	550	342	600	475	184	241
KE 7.0	7,000	2,100	700	356	340	500	480	138	203	595	372	645	500	182	284
KE 8.0	8,000	2,400	800	384	370	525	505	138	227	635	392	685	525	182	324
KE 9.0	9,000	2,700	900	418	400	565	525	143	266	635	402	690	535	199	360
KE 10.0	10,000	3,000	1,000	409	515	550	635	139	301	680	427	735	560	192	401
KE 12.0	12,000	3,600	1,200	460	445	630	570	153	352	695	452	755	585	208	471
KE 15.0	15,000	4,500	1,500	493	590	660	710	154	460	750	497	815	630	220	596
KE 20.0	20,000	6,000	2,000	577	580	775	700	179	636	840	562	910	695	240	839
KE 25.0	25,000	7,500	2,500	662	775	845	895	172	856	885	730	950	850	241	1,124
KE 30.0	30,000	9,000	3,000	697	820	900	940	191	1,072	950	785	1,025	905	255	1,396
KE 40.0	40,000	12,000	4,000	816	1,015	1,030	1,135	196	1,543	1,055	925	1,130	1,045	288	2,071
KE 50.0	50,000	15,000	5,000	917	1,015	1,170	1,135	232	2,122	1,145	1,005	1,230	1,125	314	2,684

\* Bu, Bo: Widths of anchor plates, below and above; Lu, Lo: Lengths of anchor plates, below and above

\*\* Including anchor plates

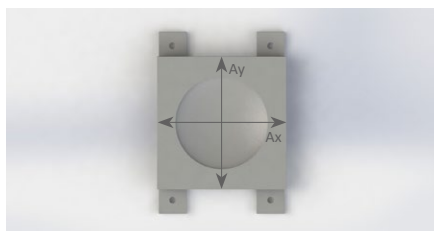

Top view of lower part of a KE bearing

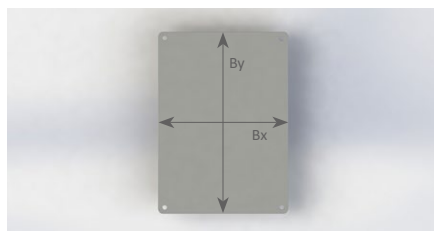

Top view of the sliding plate of a KE bearing

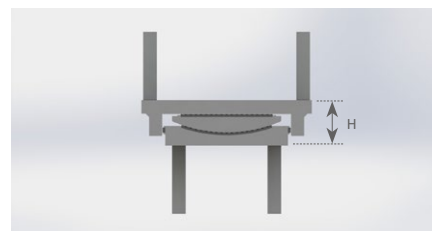

Section through KE bearing without anchor plates, with dowels



Structural bearings

# Typical Dimensions – Type KA

RESTON®SPHERICAL Bearings of Type KA facilitate movements in every direction and rotations about every axis. This type of bearing cannot transmit any horizontal forces except friction. The bearing is connected to the superstructure and substructure by means of threaded sleeves or of anchor plates with shear studs. Bearing dimensions and weights for deviating requirements can be determined on request.

### Dimensions for concrete class C30/37 (based on EN 1337)

Type	N <sub>Rd</sub> [kN]	N <sub>d,min</sub> [kN]	Without anchor plates					With anchor plates					
			D [mm]	B <sub>x</sub> [mm]	B <sub>y</sub> [mm]	H [mm]	Weight [kg]	Anchor plates*				H** [mm]	Weight [kg]
								B <sub>u</sub> [mm]	L <sub>u</sub> [mm]	B <sub>o</sub> [mm]	L <sub>o</sub> [mm]		
KA 1.0	1,000	300	183	243	303	67	30	316	316	345	316	102	46
KA 2.0	2,000	600	236	296	356	70	43	316	316	390	340	114	63
KA 3.0	3,000	900	278	338	398	77	60	340	316	425	375	124	84
KA 4.0	4,000	1,200	320	380	440	81	76	365	321	455	405	124	98
KA 5.0	5,000	1,500	364	424	484	83	95	390	354	480	430	135	120
KA 6.0	6,000	1,800	397	457	517	86	115	420	389	505	455	137	141
KA 7.0	7,000	2,100	417	477	537	104	152	435	422	525	475	148	168
KA 8.0	8,000	2,400	456	516	576	93	158	465	452	555	505	146	191
KA 9.0	9,000	2,700	479	539	599	104	193	478	478	560	510	158	224
KA 10.0	10,000	3,000	507	567	627	103	214	506	506	590	540	158	254
KA 12.0	12,000	3,600	548	608	668	120	284	560	560	610	560	186	341
KA 15.0	15,000	4,500	616	676	736	129	390	625	625	675	625	191	447
KA 20.0	20,000	6,000	708	768	828	138	539	709	709	760	710	206	638
KA 25.0	25,000	7,500	797	857	917	142	688	799	799	800	798	236	919
KA 30.0	30,000	9,000	881	941	1,001	141	835	862	862	870	856	268	1,189
KA 40.0	40,000	12,000	1,022	1,082	1,142	157	1,246	1,028	1,028	1,080	1,030	237	1,619
KA 50.0	50,000	15,000	1,147	1,207	1,267	178	1,785	1,139	1,139	1,150	1,133	283	2,310

\* Bu, Bo: Widths of anchor plates, below and above; Lu, Lo: Lengths of anchor plates, below and above

\*\* Including anchor plates

### Dimensions for concrete class C50/60 (based on EN 1337)

Type	N <sub>Rd</sub> [kN]	N <sub>d,min</sub> [kN]	Without anchor plates					With anchor plates					
			D [mm]	B <sub>x</sub> [mm]	B <sub>y</sub> [mm]	H [mm]	Weight [kg]	Anchor plates*				H** [mm]	Weight [kg]
								B <sub>u</sub> [mm]	L <sub>u</sub> [mm]	B <sub>o</sub> [mm]	L <sub>o</sub> [mm]		
KA 1.0	1,000	300	126	215	290	67	25	316	316	345	316	102	46
KA 2.0	2,000	600	175	265	325	72	33	316	316	390	340	114	63
KA 3.0	3,000	900	276	336	396	77	60	340	316	425	375	117	78
KA 4.0	4,000	1,200	309	369	429	77	71	365	316	455	405	117	91
KA 5.0	5,000	1,500	344	404	464	77	83	390	322	480	430	119	104
KA 6.0	6,000	1,800	369	429	489	80	96	420	316	505	455	119	118
KA 7.0	7,000	2,100	395	455	515	83	112	435	365	525	475	125	137
KA 8.0	8,000	2,400	417	477	537	83	123	455	385	545	495	123	148
KA 9.0	9,000	2,700	438	498	558	86	137	470	401	560	510	129	164
KA 10.0	10,000	3,000	459	519	579	88	153	490	420	580	530	129	179
KA 12.0	12,000	3,600	497	557	617	98	198	525	453	610	560	131	209
KA 15.0	15,000	4,500	551	611	671	98	237	565	494	655	605	147	274
KA 20.0	20,000	6,000	628	688	748	109	336	630	560	720	670	154	371
KA 25.0	25,000	7,500	699	759	819	122	473	695	630	785	735	157	472
KA 30.0	30,000	9,000	758	818	878	132	596	760	699	855	805	171	636
KA 40.0	40,000	12,000	890	950	1,010	151	924	830	800	925	875	193	867
KA 50.0	50,000	15,000	879	990	1,050	206	1,291	930	904	1,040	990	194	1,153

\* Bu, Bo: Widths of anchor plates, below and above; Lu, Lo: Lengths of anchor plates, below and above

\*\* Including anchor plates

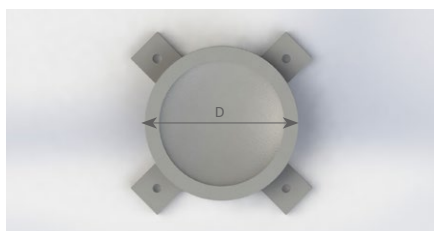

Top view of lower part of a KA bearing

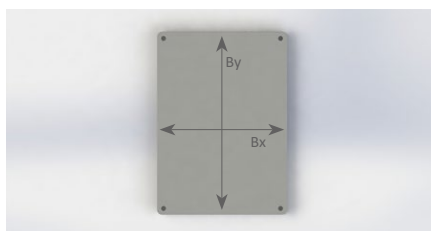

Top view of the sliding plate of a KA bearing

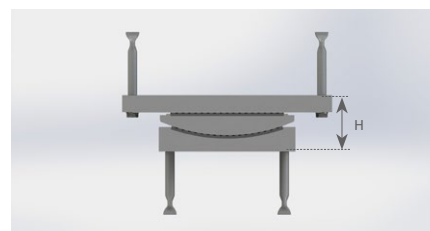

Section through KA bearing without anchor plates, with threaded sleeves